

SPRING 2014 | 1435 | ISSUE 12

INSPIRE



« ...AND INSPIRE THE BELIEVERS »

SHATTERED A STORY ABOUT CHANGE

Q&A WITH SHEIKH ANWAR | OSJ: **CAR BOMBS** | THE CRUSADE AND THE SWAP OF STANCES

COVER STORY

52 SHATTERED:
A Story About Change
Abu Abdillāh Almorāvid

OPEN SOURCE JIHĀD

62 Car Bombs Inside America
The AQ Chef

70 Car Bombs: Field Data
The AQ Chef

INSIDE THIS ISSUE

13 Rumbling Blaze Under
Calm Ash
Sheikh Nasr Al-Ānisy

26 The Crusade And
The Swap Of Stances
Sheikh Ibrāhīm Ar-Rubaysh

20 Palestine: Betrayal Of
Human Conscience
Samir Khan

38 24/7 Terrorism
Muhannad J. S.

CONTENTS

Latest & Opinion

- 3 Letter from the Editor
- 4 Hear the World
- 6 Mujahid's Notes
- 8 Inspire Reactions
- 9 Echoes Behind Enemy Lines
- 19 AQAP Statement

Misc

- 15 Sincere Advice from a Muhajir
Hāfiz Al-Uruppi
- 44 The Barrier Between
Excerpt from Mashāri'ul Ashwāq
- 14 The Arson Jihad

Manhaj Review

- 16 Q&A with Sheikh Anwar Al-'Awlaki
Sheikh Anwar Al-'Awlaki
- 32 Why Did I Choose Al-Qāeda?
Sheikh Abu Mus'ab Al-'Awlaki
- 34 Conditions of the Word of Tawheed
Sheikh Hārith An-Nadhāry

Political

- 58 The End of Safari
A Shabāb Mujahid Bro
- 46 An Interview with Obama
Muhannad J. S.
- 41 The Good, the Lamb and the Ugly
Abu Nūh

History & Strategy

- 10 Imān Defeats Arrogance
Dr Aiman Adh-Dhawāhiry
- 42 The Jihādi Experiences: Preparation
Sheikh Abu Mus'ab As-Sūri
- 28 In Hot Pursuit of Mirage
Experts
- 30 City Wolves
Abdulilāh Shā'ye'

Sisters' Corner

- 48 Mujahidah, Wife of a Mujahid
Umm Yahyā

LETTER FROM THE EDITOR

Yahya Ibrāhīm

In the Name of Allāh, the Most Gracious, the Most Merciful.

All praise is due to Allāh the Lord of the Universe, and may His peace and blessings be upon His Messenger Muhammad and those who follow his footsteps. To proceed:

Whenever Al-Qāeda is mentioned, the American citizens' mind thinks of vest and car bombs. Bearing in mind that none of these weapons has struck them post 9/11. So why would they relate Al-Qāeda to these bombs? Simply because they fear these weapons and have seen enough of their destructive power in Afghānistān and Irāq.

Many Feisal Shahzāds are residing inside America, and all they need is the knowledge of how to make car bombs. They are all yearning to fulfill their duty of Jihād.

The American government was unable to protect its citizens from pressure cooker bombs in backpacks, I wonder if they are ready to stop car bombs!

Therefore, as our responsibility to the Muslim Ummah in general and Muslims living in America in particular, Inspire Magazine humbly presents to you a simple improvised home recipe of Shahzād's car bomb.

And the good news is ... you can prepare it in the kitchen of your mom too.

NOTE: DUE TO TECHNICAL AND SECURITY REASONS, WE HAVE SUSPENDED OUR EMAIL ADDRESSES TEMPORARILY.

JIHADI MAGAZINE ISSUED BY AL-QĀ'EDA ORGANIZATION IN THE ARABIAN PENINSULA



UNEARTHED TREASURE

DID YOU KNOW?

- that America knows that Abu Anas Al-Lībi had no hand in the 1998 Nairobi and Dar-Es-Salam US embassies attack?
- that America is hiding the fact that it failed to take the body of Sheikh Usāma bin Lāden after his martyrdom?

 **@heartheworld**
A collection of quotes from friend and foe

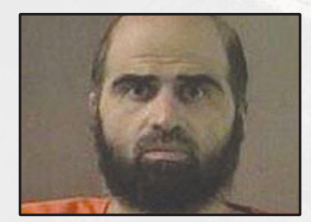

MAJOR NIDĀL HASSAN, Soldier of Allāh - Fort Hood Shooter (Court Statement):
I am the Shooter. ... The evidence will show I was on the wrong side. The evidence will also show that I then switched sides. The evidence will show we Mujahideen are imperfect soldiers trying to establish a perfect religion in the Land of the Supreme God.



ROBERT MUELLER, Former FBI Director (AFP):
Lone wolf or solo terrorists are much more difficult for us to identify and to disrupt for an attack to take place. It's hard to quantify (the threat) because you have one metric and that is preventing all attacks. If there's one attack, you're unsuccessful ... It (Fort Hood shooting) is part of a pattern we've seen recently but a pattern that probably will be replicated in the future. The existence of 'lone wolves' is why telephone and Internet surveillance programmes are 'tremendously important'.

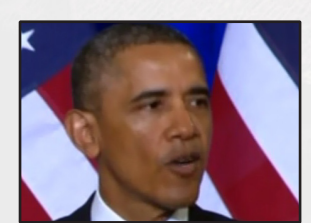

BARACK OBAMA, US President (CNN):
Across the political spectrum, Americans recognize that we had to adapt to a world in which a bomb could be built in a basement. (In a recent speech of his justifying NSA's mass surveillance.)



DR. CORNEL WEST, American Philosopher & Civil Rights Activist (Huffington Post):
I think we have to acknowledge that President Obama has very little moral authority at this point, because we know anybody who tries to rationalize the killing of innocent people, a criminal - George Zimmerman is a criminal - but President Obama is a global George Zimmerman (pointing to Obama's attempt to rationalize the killing of innocent children in U.S. drone strikes).

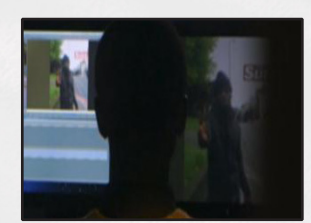

JEREMIAH ADEBOLAJO, Brother of the Woolwich Mujahid (Aljazeera International):
People may say, "Well, he (Woolwich Mujahid) is a violent individual, and he proved that on the day of Woolwich." But I would say, "Was Lee Rigby a violent individual? Are other British soldiers, who go to Afghanistan and Iraq and kill, violent individuals?"

 **@heartheworld**
A collection of quotes from friend and foe

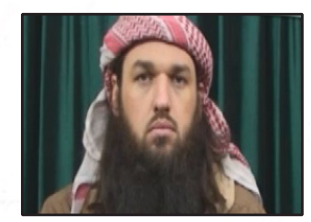

ĀDAM GADAHN, Al-Qāeda Mujahid (As-Sahāb Media):
Stand, revenge on America the enemy of Islam and Muslims. Remind us of the glories of Nairobi, Dar-es-salam, Aden, New York, Washington, Fort Hood, Benghazi and Boston. Defend your religion, Ummah and honors from America and the crusaders, by hitting their interests in our countries and theirs. The war with the crusaders and Jews is global; it does not acknowledge boundaries and there are no restrictions except those brought by the just Shari'ah or those advantageous to Islam and Muslims as seen by the trusted Ummah scholars and Mujahideen leaders.



MUSTĀFA QADRI, Amnesty International, Researcher (France 24):
We're really concerned about the US drone program. Because it claims it can use them anywhere in the world because it has a global war against Al-Qāeda and its allies. But we have to take the US on its word, because it has provided us with no information. This is a secret program. In fact, in our case we've found at least in some cases they've clearly killed civilians, and some of these cases might be war-crimes.

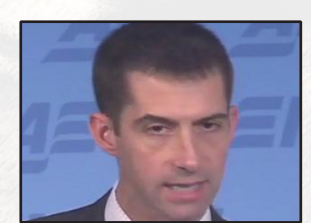

REP. TOM COTTON, Former Soldier in Irāq and Afghānistān (American Enterprise Institute):
The president likes to say that Al-Qāeda is on the run, maybe so. But only in one regard. As for many have learned the basic infantry doctrine, the infantry is on offense when it is moving, and is in defense when it is not moving. Al-Qāeda is only on the run in the sense that Al-Qāeda is on the offense around the world.



ERROLL G. SOUTHERS, Expert on Counter-terror (Interview with Hienz):
Homegrown actors can successfully attack a U.S. target with little or no resources. We have always known this was a possibility, but Boston reminded us of the adaptive nature of the threat we face. The Tsarnaevs chose to attack a marathon - a particularly difficult target to secure. This speaks to the issue of soft targets and their relative vulnerability, and the fact that violent actors seek out public gatherings that, by their nature, cannot be made totally secure.

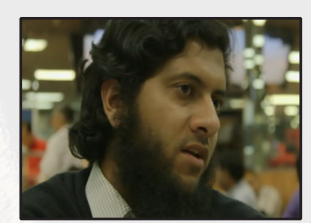

SUHEIB AMĪN, Former Brooklyn College Student (Aljazeera America):
I remember we had, you know, a political discussion in class that I really didn't want to get involved in. I remember I had one professor that said that if he was in Iraq, he'd probably be on the other side. And I remember I was just looking at him thinking I'll be in jail if I thought (of) that.

- 04 - July - 14
- to buy
- Nuts and Bolts
 - O₂ Gas Cylinder
 - Barometer
 - Sugar
 - Pizza
 - Tissue
 - pipe
 - Salt
 - Christmas lamp
 - Epoxy
 - Battery
- Buy from different shops

Mujahid's Notes

"Gentlemen do not read each other's mail."
- Henry L. Stimson
1929

- Marcos Alonso Zea: imprisoned 4 suspicion of having intention 2 travel 2 a Jihadi front. As if they read his mind!
- Free Umm Usama' campaign, slogan raised: "Where 2 da lone Mujahid who will stop the imprisonment of our sisters?"
- GAGZ: A bundle of 150 hellfire missiles 2 all what da master n leader of 'war on terror' can offer 2 support da murtad gov. of Iraq 2 fight da Mujahideen... "LOZERZ!"
- * **DEATH OF A VEGETABLE HITS NEWS STANDS!** Afta da death of criminal of war, Sharon, Obama renews his sincere commitment of support of Israel + more of spying on allies.
- Inverted scale:**
Mujahideen:
Defend women & children,
provide food & water,
support Syrian rev. and
fight da tyrant.
- * Bashar: killed 150,000+ uses chemical and Rape weapons, destroys & besieges Syrian cities.
ACKNOWLEDGED PRES.
- * The brothers in the Islamic Maghreb spread Inspire's pressure cooker bomb recipe in English, Arabic and Spanish. I pray that more Muslims spread it plus the Car Bomb recipe in many more languages.
- * Tarek Mehanina: no connection with AQ whatsoever - a doctorate, Massachusetts College. - Sentenced: 17 1/2 yrs. Charge: expression of views & translating Islamic text. Comment: I thought 'Freedom of Expression' was real.

State of the Onion:
divided / desiccated / chopped / baked
Mr. Speaker, Mr. VP, and fellow citizens. Today in America an officer shoots a child in a Honolulu school, the entrepreneur becomes richer and the homeless becomes poorer, gas prices raises by 4%. A farmer in California sows seeds in the worst drought in 163 years after a year of wildfires. A doctor treats a child from whooping cough, one of 50,000 cases. An old man walking home from job, tired, sick, instead of receiving pension and compensation for his son lost in the Service in Iraq. Tonight this chamber speaks with only one voice - voice of an ass leading olifants - directed to the subjects its rules.

2 grenades attack on a US military base in Japan. This news reminded me of Sheikh Nasr Al-Anisi's: The rumbling blaze. Obama's declaration of AQAP's danger caused me to join this front of 'dangerous' people to fight the Empire of Evil, 'America'. When the train in New York derailed, The first thought to come to Americans and Mujahideen alike was, "Is this a lone Jihadi Operation?"

"M-16 was the reason behind the failure in Iraq" - ~~The American government~~
LOL222
Adam Sandler
or is it just in respect of the death of Kalashnikov.



Remember, remember
The 5th of November
Nidal Hassan's treason and plot
I know of no reason
Why Nidal's treason
Should ever be forgot
Brother Nidal Hassan shot n killed 60 US officers, an act of vengeance not in vain. He grabbed his machine gun seeking martyrdom and 4 years later he is closer to his hopes: being killed in the Way of Allah soon.

- Washington
- New York
- California
- Los Angeles
- Atlanta
- Houston
- Chicago
- Dakota
- Train crude oil
- Miami
- Dallas
- embassies
- restaurants
- power plants
- matchsticks
- pressure cooker x2
- dates, honey n coffee



Meeting
3pm
TODAY!



INSPIRE REACTIONS

government & media responses

“The US has no protection from these types of operations unless it plants bugs in citizens’ heads to monitor their thoughts ... and success in this regard cannot go beyond capturing the perpetrators after they execute their operations.”

Note first that the magazine did not stop publication after the assassination of Sheikh Anwar Al-Awlaki, Samir Khan and Abu Yazeed al-Qatari, and therefore the effective incitement did not stop. That means that al-Qāeda has substitute commanders ready. The Boston operation will inspire other operations and other perpetrators inspired by the ones who did the previous operations and the same motivations and so on etc. This is why AQ refers to the recent Woolwich operation in the UK.

The fact that the Internet links to the magazine and the magazine itself were pulled down MINUTES after it was released gives an idea of the extent to which the US is nervous. No other Jihādi media product seems to produce such erratic behavior in the US.

The US has no protection from these types of operations unless it plants bugs in citizens’ heads to monitor their thoughts ... and success in these regard cannot go beyond capturing the perpetrators after they execute their operations.

[Abdurazāq Al-Jamal - Yemeni Journalist]

I don’t think Al-Qāeda has a First Amendment right to put out its propaganda, to encourage people to commit acts of terrorism. Unfortunately, I think Inspire magazine is a significant threat to the extent that it disseminates information about how to build a bomb or encourages people to get radicalized. It has shown a dangerous effectiveness. And one that’s difficult to address.

[Rep. Adam B. Schiff (D-Calif.)]

The issue also contains a brief article by Mohammed Al-Sanāni entitled “An Eye for an Eye” that mentions the May 22 murder of British soldier Lee Rigby in London, complete with an iconic image of one of the alleged killers, Michael Adebolajo, with bloodied hands, a knife and a cleaver. Another brief article mentions the tornado that devastated Moore, Okla., on May 20. Ibrāhim’s ability to work these recent events into this edition demonstrates a nimbleness we have not seen in Inspire Magazine since the death of former editor Samir Khan in 2011. This indicates Ibrāhim and his team are growing more comfortable with the publishing process.

[STRATFOR]

Abraham H. Foxman, the ADL’s national director, said Inspire’s actual focus was incitement against Jews. “Anti-Semitism fuels the blood lust of Al-Qāeda’s Inspire magazine,” Foxman said. “Since the early days of Osāma bin Laden, Al-Qāeda has never made a secret of their animus toward Jews, and its current leadership continues to call on its supporters around the world to target Jews and Israelis for acts of terror. Inspire magazine is anti-Semitic through-and-through and their use of incitement against Jews has served as a central tactic in the terrorist organization’s recruitment process.”

The articles and letters in the 11th issue of the magazine encourage additional attacks on US soil and mentions the Tsarnaev brothers use of the magazine for their attack. According to US officials, the brothers got bomb-making tips from the publication. Tamerlan Tsarnaev was

an ardent reader of other Jihādist websites and extremist propaganda, US officials have said.

The issue features tweets from ‘the mujahideen in the Arabian Peninsula’ celebrating the bombings and includes a section lauding the Oklahoma tornadoes.

[TIMES OF ISRAEL]

Western intelligence agencies are clearly concerned about the effectiveness of Inspire as a recruitment and radicalization tool.

[MEMRI]

This (release of Inspire issue 11) was a bit of the buzz yesterday as this conference of the major city police chiefs and the top of FBI officials, but the bottom line is this issue of Inspire Magazine if you will a bit of victory lap. They picture numerous articles and pictures of the Boston Bombings. They feature articles and photos from the London’s beheading of the soldier, and their basic point actually echoes what New York police commissioner told this group of police chiefs and FBI officials the other day here in Dallas, which is the new model of terrorism, independent operators who are reading into Al-Qāeda narrative online, getting their instruction actually right out of Inspire Magazine and how to make the bomb. And they call it, ‘A perfect case for low cost investment’, citing the Boston example.

[CBS THIS MORNING]



ECHOES BEHIND ENEMY LINES

“To some degree it matters who’s in office, but it matters more how much pressure they’re under from the public.”

– Noam Chomsky

Smokey:

How is it that the world’s only remaining superpower, the nation that defeated the Third Reich and the Soviet Union, is quaking in its boots before a few dozen arabs?

GymRat:

The thing that gets me is why does Obama still carry qudos, its apparent for all that he is even worst than bush, and yet celebrities flock to him, even the desperate Malala wanted a piece of the obama.

Bilderberg CEO:

Richard Nixon? He got busted spying on his competitors, and he resigned. Obama has the NSA spying on the ENTIRE COUNTRY and he is still in office.

John McKane:

If we don’t change our stupid foreign policies, there will sooner or later be many more people overseas wishing to do this country harm! We’re already the most hated country in the world and through our own stupidity that will only get worse. Moreover, we’re spending ourselves into oblivion over this!

JBlargle Zog:

Seriously, we need to stop invading foreign soil. I know it’s in our nature but we have better options.

Terri Lynn Sullivan:

This day and age, it’s hard to respect the ignorance and blind faith, together with the blind “allegiance” of any American citizen that believes USA’s wars and occupations somehow “serve our nation”.

Sawyer White:

You call them terrorists yet AMERICA is the country who is attacking and bombing other nations. WAKE UP! I have seen the enemy and we are them!

Jackross:

Because the Pentagon, and the US government are addicted to killing. A drone strike that vaporises a dozen innocent bystanders is like a first cup of Joe in the morning. The nutters couldn’t get through the rest of the day without one.

Billy Nelson:

You people who think it’s all good to go to the Middle East and kill innocent people are morons. THAT IS WHY 9/11 HAPPENED IN THE FIRST PLACE!

McBride:

Civilians enjoy fireworks. It’s a part of the Fourth of July. But vets who served in war zones and [have] gone through mortar and bomb attacks, those sounds trigger to the body that they’re under threat.

Lisa (vet’s widow):

It’s not just families like mine that know sacrifice so intimately. We don’t get a do-over, we don’t get our husbands home, we can’t regrow them. We just have to figure out how to move forward in a positive way.

Midgick:

Our Country really needs to concentrate on America and not all these other Countries. We have millions of poor and hungry people right here in the good ol USA. Take care of your own, then maybe you can address the World’s problems. Want to solve our \$\$\$ problems then concentrate on us, not them.



IMAN defeats ARROGANCE

■ Dr. Aiman Adh-Dhawāhiry

The following is the first part transcript translation from a film released by As-Sahab media entitled 'IMAN DEFEATS ARROGANCE' a speech by the amir of Al-Qāeda - may Allāh preserve him.

In the Name of Allāh. All praise is due to Allāh and may His Peace and Mercy be upon the Messenger of Allāh, his family and companions, and those who follow them. O Muslim brothers wherever you are; Assalāmu 'Alaikum Warahmatullāhi Wabarakātuh. To proceed:

Twelve years have passed since the blessed Battles of New York, Washington and Pennsylvania and since the American ignorance of invading Afghānistān; an American ignorance that led to the crumbling of the American pride and exposed the crusaders' weakness. An ignorance which entangled America in Afghānistān and Irāq, and eventually running away from both defeated.

The concerns of the US president, his regime and congress is no longer about winning the war but more of surviving and escaping from Irāq and Afghānistān. The imbecile bull, Bush, dragged America into Irāq and Afghānistān. When he failed and was defeated, the ruling forces in America came with a devious president who deceived Muslims and the oppressed. They came up with an apostate president whose father was a Muslim of African origin. "Maybe he will succeed to put an end to the disaster." He said in his election campaign that the war in Irāq is a war of choice, and that he will leave it to focus on the war of necessity in Afghānistān. So he left Irāq, and now he is leaving Afghānistān, and he has no choice apart from declaring defeat. He had nothing to be proud of in front of the congress better than declaring a run-away from Afghānistān.

The global media tries to conceal his failure in Afghānistān. They agreed not to cover America's retreat. But a historic failure is horrible enough without being covered, and ugly enough without being distorted.

In order to preserve what is left of his pride, he said that he is winning over Al-Qāeda, he will defeat them with spying drones. When did planes bring victory to a run-away army?! If planes are sufficient, they would have sufficed in your savage bombardment of Vietnam, whereby you left it, defeated, after you have burnt it down to the ground with your planes. And when the flame of Jihād roared inside America, he stood up stumbling: "Al-Qāeda core is decimated and it has metastasized into regional groups that can pose significant danger." He made a joke out of himself before history. He then said that the Boston incident has questions that need to be answered. And if he was truthful he would have said, "The Boston incident poses questions we are running from answering."

The Boston incident proved to the Americans the extent of their lies and deception on their selves. It proved their arrogance to accept truth as obvious as sunshine: The fact they are not facing individuals, organizations or groups, but they are facing a revolting Ummah that has marched forth to Jihād to defend its souls, honor, glory and sacred places.

What the American regime is refusing to confess is that Al-Qāeda is a message before being an organization. A message which has spread and reached by the Grace of Allāh, and Muslims have embraced it. The message is simple and comprehensible: "O Muslims, if you want to live freely, gloriously and honorably, you have to defend this glory. "

America is not a legendary power, Americans are just men like any other. They can be defeated, punished and can conspicuously fail. And here it is, the power that considers itself the most powerful force in history has been hit in its own house. It has been defeated in Irāq and then in Afghānistān in the hands of simple Mujahideen who carry AKs and knives.

This is a defeat of technology in the hands of Iman (faith), a defeat of an empire in the hands of certainty. It is a defeat of the Western crusader capitalism values in the hands of Islam, Tawheed, Taqwah (piety) and 'Iffah (purity).

How many were the forces of the Islamic Emirate under the leadership of Amir Mullah Muhammad Omar Mujahid - may Allāh preserve him? How many were the American forces that came with their arrogance and masses? But Mullah Omar had the right insight when he said: "Allāh has promised us victory, and Bush has promised us defeat. We shall see who is truer in his promise."

Americans, through their foolish policies, are adding kerosene to the fire, every day. The recurring crimes committed in Palestine, Afghānistān, and the tribal regions of Pakistān and Yemen, and the continuous plundering of Muslim riches - which Sheikh Usāma bin Lāden (may Allāh have mercy on him) called the biggest theft in man's history, the blasphemy against Muslims sanctity and the honor of the Prophet ﷺ, the massive armies occupying Muslim lands, the crusader military bases spreading and besieging the Muslim world and America's support to the corrupted tyrannical regimes in the Gulf and the Islamic and Arab world; all these crimes increase the Muslims' urge to confront the American imperialism.

Indeed, the crimes America perpetrates against Muslim prisoners will not be forgotten by the Muslim Ummah. The fact that America neglected what it has signed in the Geneva Convention; prohibition of physical and psychological torture of Muslim prisoners, detaining them in black sites whereby their families know nothing about them, detaining them for undefined time without being charged, all these crimes give Muslims more rights to stand in the face of the American aggression, and to treat America as an equal.

One of the first things Obama did in his presidency is pardoning the CIA agents who tortured Muslims. In so doing, he sent a clear message to Muslims; "We will still torture your prisoners, and all the treaties we signed that

prohibit torture in dealing with prisoners are for our right and not yours. Expect nothing from us except criminality, torture and insults."

O Muslim brothers, we will not liberate our prisoners except by force, the only language America understands. Prisoners will not be freed by hopes, begging or protesting. But they will be freed by taking prisoners from our enemies just like they take from us.

The blessed battles on September 11 were a result of America's recurring crimes against Muslims, and its occupation of Muslim lands. And until today, twelve years after those battles, America has perpetrated more crimes, inspiring Muslims to repeat such attacks.

Indeed, among the glad tidings of victory to the Muslim Ummah is that Americans stick with the same mistakes, they persist to run in the same dark tunnel, and they jump from one failure to another, and from one defeat to another. This is the Plan of Allāh to destroy them as He has destroyed arrogant nations before. Prophet Mūsa - Moses peace be upon him - made a Du'aa against Fir'aun (Pharaoh) and his people: *﴿And Musa said: "Our Lord! You have indeed bestowed on Fir'aun and his chiefs splendor and wealth in the life of this world, our Lord! That they may lead men astray from Your Path. Our Lord! Destroy their wealth, and harden their hearts, so that they will not believe until they see the painful torment.﴾* [Yūnus: 88]

This is the arrogance of empires that refuse to accept the true state of affairs, hence they lead themselves to destruction. This American arrogance necessitates Muslims to resist. Resistance is not impossible. We have to exhaust

America's economy by provoking it to continue with its enormous spending on its security. America's weak point is its economy which is staggering from hemorrhage in military and security spending.

And if Allāh gives us *tawfeeq* and success to continue to provoke it to bleed more financially in military and security, it will soon fall, *Biidhnillāh*, just like other arrogant empires fell before. The continuation of America's hemorrhage in military and security spending requires us to make America worried and anticipating, "When and whence will the next blow come?"

And to make America continue to be worried costs us nothing but a number of strikes here and there, i.e. Just like the way we defeated it by guerilla war in Somalia, Yemen, Irāq and Afghānistān, we should follow it with a war inside its own home. These different strikes could be done by one or a few brothers. Together with these strikes we should look out and wait for any chance to hit it with a big blow, even if we would have to wait for years.

In addition to that, we should inspire our Ummah to boycott America's economy and its allies'. We should explain to them that every dollar spent on any American merchandise or that of its allies turns into a bullet, shrapnel or a projectile that will kill a Muslim in Palestine or Afghānistān, or turns into fuel for their tanks, planes and ships that occupy our lands.

Moreover, we should inspire our Ummah to stop using the Dollar and replace it with currencies of countries that do not take part in this aggression against us.

ΒΟΜΒΙΝΕ ΒΓΥΣΕ UNDER CALM ASH

■ Sheikh Nasr Al-Ānisī

The western media endeavors to portray the American empire as old favorite, the defender of peace, the number one human rights protector and that it has values and principles that they call to. Is this the feeling of billions of people? Do people really buy this? Or is the reality different?

If the American people have been convinced of this, then they are in big trouble. They do not know the hell and wail awaiting them, especially with their great nation breathing its final.

Do you remember, o American people, how much you ridiculed the Russians when they clapped for Gorbachev in Kremlin, while the Soviet Union was collapsing and falling down? It really was a farce; disgracefully ignoring a situation that no government respecting its people can ignore. Don't you see that what you ridiculed in the past is what people ridicule you and your government with today?

Isn't it more reasonable for the American government to be frank with its people regarding the true state of affairs? Isn't it time for it to talk openly to its people on what the near future holds for them? Isn't it the American people's right to know what awaits them? And how to face the future?

What makes this critical is America's mastery of creating enemies. It has been totally successful in gathering worldwide enmity through its tyranny and imperialistic policies.

Do you think the Japanese have forgotten what happened in Hiroshima and Nagasaki? Do you think America's atrocities in Vietnam and Panama could be forgotten? Even what took place in Germany, do you think Germans have forgotten the degradation subsequent to the second world war? Don't think Germans have forgotten. The starvation victims will never forget the thousands of tons of wheat you disposed of in the ocean while thousands of children were dying in front of their eyes, the millions of children who died under your arsenal's besiege and as a result of the radiation from your forbidden weapons. They died in wars their short lives were never part of. It is simply out of question for the nations oppressed by America to forget, it's a matter of a rumbling blaze under calm ash, buried hate burning in their hearts. A time bomb. They all wait for the right moment to take revenge.

I augur badly for you. A terrifying dark future awaits you; a moment of revenge, not only from Muslims, but also from many enemies some you may not know and some you may have forgotten, but they will never forget you.

Nations pass through same stages men pass: birth, childhood, prime of youth, old age and then struggle with death; and there is no sane person doubting that America has reached the latter. Like men, nations' final days differ. In the end, both men and nations harvest what they sowed.

Therefore, a nation with the most hideous crime history known to man should not dream of a happy ending on a warm comfy bed.

QUESTIONS | we should be asking

- If the US drone strikes on Al-Qāeda are working, why are the Mujahideen in Yemen after all these years able to make the US close 22 of its embassies in Africa and Middle East for a week?
- How could a week closure of US embassies protect American interests throughout the year? Or was the closure saga a justification for NSA's illegitimate programs?
- Is the modern Buffalo soldier worth a Labrador? Would the US Army at least honor them with Dickin Medals?
- If 26,000 rapes and sexual assaults are perpetrated in the American army in one year, how could a man with a speck of manhood let his wife, daughter or sister join the US Army while the sex predators in uniform are the bosses?
- Isn't it saddening that Bo, Obama's dog, dines with the tax payers' money better food than that of 100 million Americans?
- If those making blasphemy against Islam have the right to express themselves, why aren't the actions of Assange, Snowden, Manning and Hammond considered freedom of expression?

NUMB3RS SP3AK LOUD3R

In US, one in four young black men say police treated them unfairly. Moreover, 24% of black males aged 18 to 34 say that they have been treated unfairly by police in July 2013 alone, compared with 13% of young Hispani males who say the same.

Gallup Editor-in-Chief Frank Newport

79% of Americans believe the economy is still in recession vs. 19% do not think so.

Washington Post/ABC News Poll (Dec 2013)

1 in 3 parents of K-12 children fear for the safety of their kids at school.

Gallup (Dec 2013)

Sincere

advice from a muhajir

■ Hafiz Al-Uruppi

Rasūlullāh ﷺ said in a *Hadeeth*, “Deen is giving advice.” So I want to do just that, and advice my dear brothers and sisters of the Muslim nation, especially those who for some reason are still residing in Europe and the USA, to join the ever growing ranks of the Mujahideen in the lands of *Jihād* or do operations inside *Dār-ul Kufr* itself. You don't even have to do it as a group. Do it on your own. Don't tell anyone, not even your closest friends. And remember that you have so many tools available. If you need any ideas just go online, preferably an internet-cafe so the security forces can't track you easily. Also do not forget to use proxy programs. Suffice it to say you can get some help from this magazine, *Inspire*.

If you have *Ikhlas* and seriously sit down and think about what this Ummah is going through, and what your brothers and sisters are going through all over the Muslim countries, you will *Inshallah* realize that its *Fard-Ein* upon you to do your part and defend them and try to release this Ummah from the state that it's in. What is it that detaches you from the rest of the Ummah!? We have to struggle to establish the Shari'ah of Allāh. It's not something that you get for free, or just by praying the 5 prayers and make *du'aa*, it is established through blood and sacrifice of everything ... everything!

As for me, I was born and lived 30 years in Europe and I know everything about life there, and it's not good for a Muslim soul to live in such an environment. The things your eyes are exposed to are not good for a Muslim. Everytime you turn on the T.V your eyes are exposed to something *Harām*. Don't you know that your eyes will testify for or against you on a day which is 50,000 years long? Do you even dare to let that thought enter your mind!? And what about the *Hadeeth* when *Rasulullāh* ﷺ said,

“The Muslim who resides in *Dār-ul Kufr* is not my responsibility.”

One of the reasons I made *Hijrah* was after I saw a couple fornicating right next to the stairs of a church in my country. Then I said to myself, “OK, that's it!” I made arrangements and tried to make *Hijrah* at once but was denied entry to Yemen because of visa problems. But *SubhanAllāh! Inna Allāha Ma'a As-Sabireen*. One year later Allāh arranged it for me and I entered against all odds ... all the way to Abyan - *Alhamdulillah!*

And you, my dear fellow Muslim. If you don't go now, when will you go? How long are you going to stay in *Dār-ul Kufr*, listening to the *imāms* who say, “This is the time for patience and tolerance, we are in the Mekkan period, we are too weak, we should just give up ...” NO! This is not the Mekkan period, that was over 1400 years ago.

Most of the real scholars, whose primary task is to guide the Ummah, are either in prison, killed or they are with the Mujahideen fighting.

Don't expect the scholars that you see on T.V and the internet to guide you through their *Khutbas*. You should know by now that this is not the time for forbearance and tolerance, not the time to give up, but rather the time to rise up and fight with whatever means are at your disposal.

Dear Muslim, don't you see the banners of *Lā Ilāha Illa Allāh* being increasingly raised in the streets of our nations? Don't you want a piece of the reward that comes with that? The Ummah is calling for you, and now we have armies of Mujahideen in Irāq, Afghānistān, Pakistān, here in Yemen, Algeria, Mali, Somalia, Syria, Chechnya, Dagestan, Egypt, Nigeria, Libya, and the list goes on, *Alhamdulillah!* Don't you want to be a part of the armies that raises the banner of *Tawheed* and will, *Inshallah*, reestablish the *Khilāfah*? We will not establish that without weapons and sacrificing whatever it demands.

Don't forget us in your *du'aa*.
Wa Alhamdulillahilāhi Rabbil Alamīn.

THE ARSON JIHAD

lex talionis

Tsarnaev in the woods, balances the equation. Incognito to men, but Allāh is the All-Knowing. He looks around, buildings and houses destroyed, people displaced. He thinks, “I recall watching similar videos. ... Aha! Palestine!” He looks up in the sky, “Planes in the US? A familiar scene in Waziristān, Somalia and Yemen. *Lex talionis*: wildfire for Hellfire; tit for tat.” He listens to the radio. “What? Reservoirs contaminated? That isn't even news! Americans' waste has contaminated the Somali coast more!” He exclaims. He watches the Weather Forecast, “Climate change in the US, blah blah blah. So? Nothing new, the same result as that of the American industries in Africa and Asia.” He prays his *fardh swalāh*, he raises his hands towards the heavens, tears pouring down his face, “O Allāh, accept my *Jihād*.” He takes his ticket out of his pocket. It's time! Off to another state to increase America's debt with his modest matchbox.



Q & A

with
Sheikh Anwar Al-'Awlaki

- may Allah accept his martyrdom -

Sheikh Anwar's answers for questions sent for the program, 'Send your questions to Sheikh Anwar Al-'Awlaki' advertised in Inspire Issue VI

E-MAILED QUESTION:

Q: With regard to the ruling on killing non-combats:

Sheikh 'Uthaymīn says that it is allowed to kill non-combats if they kill our non-combats, because of the *ayāt* that say, that we can do the same to them as they do to us, but some say that this is incorrect, because if the *kuffār* rape Muslim women, we can still not rape their women. What do we say to these people?

A: First of all, some things need to be made straight:

It wasn't the Muslims who dragged in civilians into this war. It was the Americans, and on a scale that is astronomically different than ours. They killed millions of Muslim civilians in cold blood during the embargo of Iraq which was before 9/11.

Secondly, it is amazing how the West wants to go about its imperialistic greedy oppressive business of occupying, colonizing and plundering the wealth of the Muslim world, supporting a racist and brutal occupation in the heart of the Muslim world, Palestine, and then does not expect any retaliation whatsoever from the Muslims. And with all insolence, paints the Muslims who are defending themselves as the aggressors. I mean this is something that could never pass if the West did not have the tools to pass on such a lie and such an unbelievable distortion of history, but the West does have such a tool and that is the media. The media succeeded in distorting the facts and presenting wrong as right, evil as good.

Now back to the topic of targeting the populations of countries that are at war with us. Is it allowed or not? Well, first of all, why is the West so concerned about this issue, why do they talk about it a lot? This emphasis on this form of war is proof that it hurts them. It hurts the West when we target their civilians and it concerns them and worries them, and this is why they are spending

so much effort in trying to scare us off from adopting to such measures. Because for those who understand how a democracy functions, when a group starts targeting the population of a democratic nation rather than its army you could end up opening a Pandora's box that the political elite fail to control. You do not know how the masses would react. In Spain for example, after the Madrid bombings they kicked out the Aznar government. A population in a Western country may start asking questions if they feel endangered, they might start asking, "Why are we fighting wars 1000s of miles away? Why are we supporting Israel? What benefit to us a society as a nation do we get from supporting Israel? Is it worth the price? These are questions the political elite in Western countries do not want their populations to ask, and therefore, they want to keep their populations at sleep and ironically, it is the operations of the Mujahideen, that are targeting these populations, that might wake up these populations and make them ask the questions that are important for them and that they should be asking. But if the attacks don't wake them up and end up making them more resolved to carry on with supporting their governments in their anti-Muslim policies, then fine, they have received what they deserve as voters and tax payers who are participating in the war against Islam with their wealth and vote.

Therefore, if you ask me as a tactic, is targeting the civilian population of the West a good thing to do? I would say yes, because it is much more potent and powerful. Soldiers are expected to die anyway. That's why they sign up for the army, to fight and kill or be killed. So a soldier is at risk anyway and that risk is factored into his job. But a civilian is not. So when you hit the civilian you hit them where it hurts most and that is what our tactics are about.

I would also want to say to my brothers that we want to understand what is

the objective of our operations: The primarily objective is not to achieve the most deaths but to achieve the most effect, the most leverage.

So an operation such as the parcel bombs did not actually kill anyone but it achieved an effect that may surpass an operation where tens of people get killed. That is because the parcel bomb operation, which the enemy calls foiled parcel bomb plot and we call Operation Hemorrhage and consider it to be successful by all means, will end up costing the enemy billions of dollars in added security measures, billions of dollars in lost revenue because of stricter security measures, a xenophobic knee jerk reaction by the Obama administration that introduced mandatory new security measures in all US airports which would cost money and most importantly aggravation it would cause to the American people.

It is interesting how the American government claims that we attack America because of its freedoms and then use our operations as excuses to curtail the freedoms of the American people. Civil liberties in the West are a self-inflicted casualty of war.

America and the West along with it are on their way out. Our brothers need to realize that their operations against the West are critical at this stage of our war because they would reveal that the war on terror was in fact a failure and a mistake and that war against the Muslim world is not the way to defend the West.

But first we need to look into whether this is *halāl* or *harām*.

We look into two situations from the time of the Messenger. *Bayāt* and the mangonel.

Bayāt was where the enemy would be attacked at night, ambushed, and during the fighting inevitably women and children and elderly get killed because of the darkness. *Rasūlullāh* ﷺ was asked about permissibility of

killing women and children during *bayāt* and he allowed it. This is in authentic narrations from *Imām Muslim* and others.

Imām Ahmad was asked about the permissibility of using *bayāt* during his time he said, "And aren't our incursions against the Romans but *bayāt*?" The matter is so agreed upon that *Imām Ahmad* says, "I do not know of anyone who has discouraged *bayāt*." The mangonel was used by the Messenger of Allāh during the siege of *At-Tāif* and was used by the generations of Mujahideen following that.

Ibn Rushd says: The general body of scholars agree that it is allowed to strike forts with the mangonel whether there are women and children in them or not. *Imām Abu Hanifa* says that if the Muslims lay siege to their enemy and the enemy stands on the walls with the children of Muslims used as shields we should strike them with arrows and mangonels but with having the intentions of not attacking the Muslim children.

Imām al Shāfi' says: That has been the tradition of the Muslims and the righteous predecessors from the companions of the Messenger of Allāh ﷺ in regards to the fortresses of the enemy and it has not been narrated to us that anyone of them stopped short of attacking a fort by mangonels or other forms of weaponry just because there are women and children among them or because there are those that shouldn't be killed among them.

Do we throw out 1400 years of war methods out of the window and suddenly come up with new rules? That's how they did it. *Rasūlullāh* ﷺ, the *sahābah*, the *khulafā al rashidūn*, the Ummayyads, the Abbasids, the *Mumlūks* and the Ottomans all used catapults and later on artillery to bomb cities. That's what a catapult does, it throws a missile whether it is a rock or a container filled with combustible material into a city and it could hit a

woman or a child just like it could hit a man. That is exactly what placing a bomb in Washington or London or any other Western city is. It is no different than what our predecessors used to do for 1400 years.

On the other hand, we know of the *hadīth* that prohibits the killing of women and children, so how can we combine what was mentioned below with such *hadīth*. The answer is that women and children should not be singled out, should not be specifically targeted and if they fall as prisoners of war it is not allowed to execute them. Throughout our history whenever women and children would fall captives there lives were spared unlike with the crusaders for example who slaughtered thousands of Muslim prisoners or the Moguls who wiped out the entire populations of numerous Muslims cities. However when men, women and children are mixed and integrated such as in a city or village there is no doubt that it is allowed to target them while carrying the intentions of not specifically targeting the women and children. Therefore, an attack on a population center such as a US, British, French or German city with a bomb or a firearm attack is definitely allowed.

Then we should look into the other issue which was mentioned in the question and that is that we are allowed to do to the enemy what they do to us. You see war is a matter that takes place between two parties. So you cannot set up rules that restrict yourself while your enemy does not agree to abide too. The US, Britain, France, are all guilty of horrendous human rights abuses against Muslims so who are they to lecture us on ethics of war. And who is this Muslim who has the audacity to tell us that we are not allowed to retaliate against America or its allies when American drones have attacked Pakistan over 100 times in 2011 alone! And we all know who are the casualties of drone attacks.

E-MAILED QUESTION
Q: My question is not an unusual one, many of our brothers have asked similar questions before. I have a desire to give my life in the Way of Allāh S.W.T. and get martyred in His Way and confront with enemies in the phase of '*bil yadd*' (by action). But we're not given this opportunity due to some security problems which our brothers are facing because of the difficult time that we're going through. Secondly, if a person has an urge to fight in Allāh S.W.T's Way and he has no channel through which he can approach the brothers on the battlefield, what shall he do? He cannot find anyone who can lead him to join the brothers but has a deep urge to fight in Allāh's Way and give his life for Allāh S.W.T., what shall he do? Plz answer these questions to me as I'm not able to find anyone.

A: Whether the brother has a channel to join the brothers or not it is better for him to perform his duty of Jihād in the West. On the battlefield, you are just another soldier, but in the West you are an army on your own. When *Nu'aim bin Mas'ūd* came to *Rasūlullāh* ﷺ as mentioned by the narrators of *sīrah*, *Rasūlullāh* ﷺ told him: with us you are only one man but go back to them and weaken them as much as you can. Our advice to you is: Among us you are just one man, remain where you are and weaken the enemy from within as much as you can. If we have brothers bringing the battle to the US, France, Britain, Germany, Denmark, Australia, that would have much more effect in weakening the enemy than having brothers join us from those countries. The West brought us war and destruction let's give the West back what it gave us.

SUBJECT: CONDOLENCES FOR THE KILLING OF THE LEADER HAKIMULLĀH MAHSŪD



QĀ'IDAH AL-JIHĀD
IN THE ARABIAN PENINSULA

THE MARTYRDOM OF THE LEADER HAKIMULLĀH MAHSŪD

All praise is due to Allah Who says: ﴿Think not of those who are killed in the Way of Allāh as dead. Nay, they are alive, with their Lord, and they have provision﴾ And may His Peace and Blessings be upon the Messenger of Allāh who said: "I wish I could fight in the Cause of Allāh and be killed, then fight and be killed, then fight and be killed.

To proceed:

We have received with lot of sadness the news of the killing of the leader Hakimullāh Mahsūd together with his Muslim brothers by a treacherous American airstrike. We pray to Allāh to accept them among the martyrs, and raise their dwellings.

We offer our condolences to the Muslim Ummah in general for the loss of this heroic Mujahid leader, who together with his brothers from the tribes of Waziristān played a historic role in repelling and waging Jihad on the American Crusade on Afghānistān. They opened their hearts and houses for their Muhajireen brothers and presented the greatest of sacrifices: their sons' blood. We also specify with this condolences the defiant Pakistāni Muslim nation which we look up to with all respect, honor and admiration. And on this occasion, we inspire them to continue with their revolt against the blatant American violation of Muslim lands. And inspire them to strive to remove the consecutive lackey governments that sell Muslim blood for a handful of illegitimate money, and that trade in the people's suffering and feed on their wounds.

To conclude, we remind the whole Muslim Ummah that the killing of leaders and notable Mujahideen grows the flame of Jihad and fills hearts with hatred towards the enemies of Islam. And the course of Jihād will continue - by the Grace of Allāh - until the infidel occupiers leave Muslim lands and Islam heads over this world. Indeed, Allāh has Power over everything.

And our final prayer is: All praise is due to Allāh the Lord of the worlds.

Al-Qā'idah Organization in the Arabian Peninsula

Samir Khan

still inspiring the believers
scroll down to read the brother's inspiration

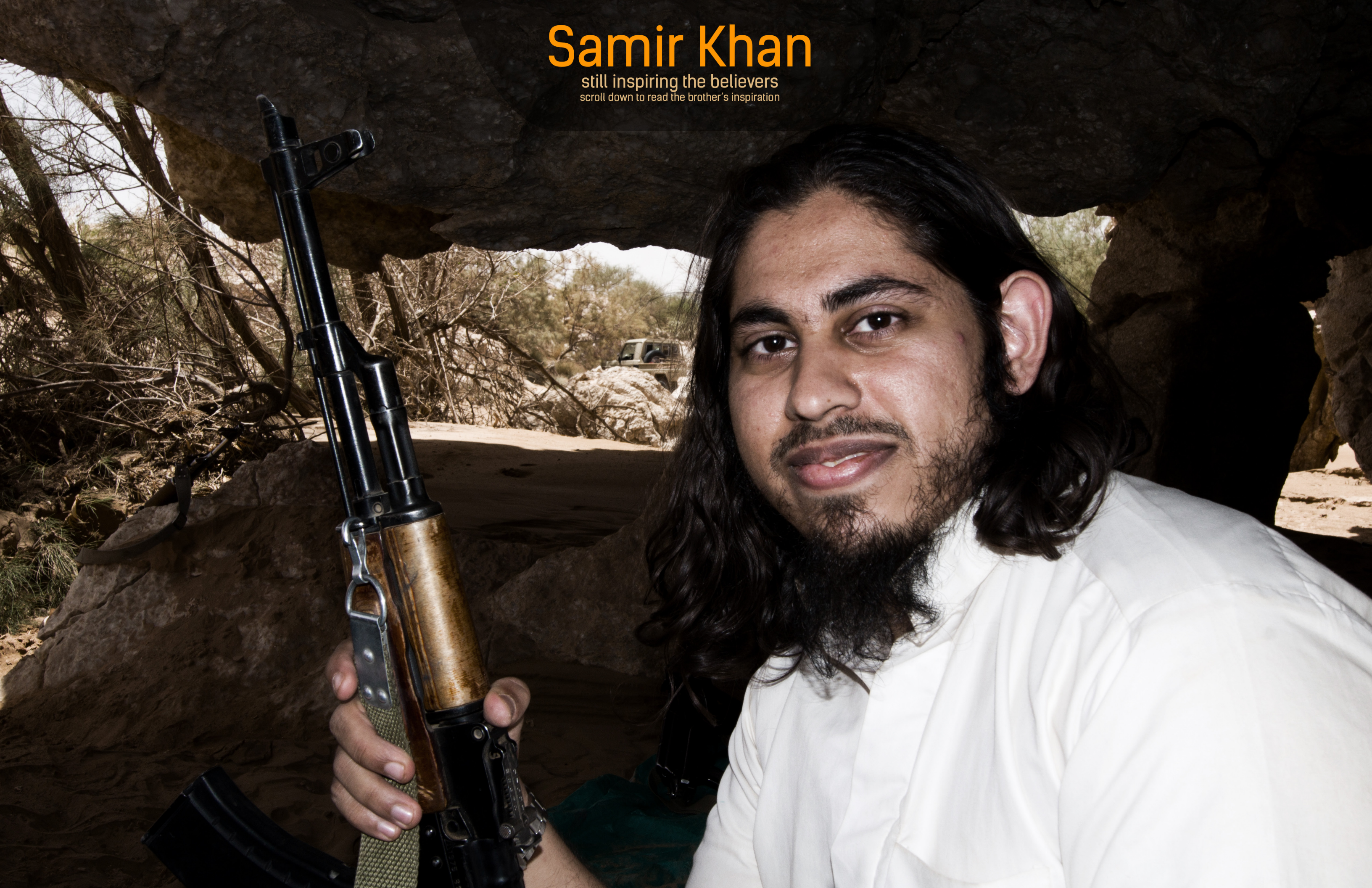

A treasure left behind by the martyr of *da'wah*, Samir Khan, may Allah accept him. It takes more than a missile to kill this kind of a hero.



PALESTINE: BETRAYAL OF HUMAN CONSCIENCE

■ samir khan

This is not a historical analysis of the Israeli dilemma. Nor is this an endless list of crimes that the Israelis perpetrated against Palestinians, activists and foreign journalists. Rather, this is a spoken word from the heart of an individual that has been crushed by the cries and calls of the helpless, weak, downtrodden and oppressed people of Palestine. This is an honest reflection from a Muslim who discarded his American citizenship for the sake of sacrificing his life for the Cause of Allāh in order to channel this rage that the world witnesses nearly everyday.

Don't think for a moment that my words are written here in hopes that an army of disbelief will come and 'save the day'. The utter reality is that no state army today would sacrifice their soldiers for a righteous and praiseworthy cause except the Mujahideen; the ones who left and continue to leave everything to protect their Ummah. Here, I want to speak to you – the Muslim who professes the Islamic faith – on a subject that would make your guilty conscience beat harder than the pounding drums. No, this is not a story of an individual or an eyewitness account of the Israeli brutality; rather, this is an attempt to find my soul ... your soul ... amidst all the rubble, blood and madness.

Years ago, as an Islamic activist, I attended meetings, taught at classes, took part in anti-war protests, ironed my religious and political thoughts out on the internet and called people to Islam. I used to have lively discussions at my local *masjid* with Muslims of various backgrounds. We all certainly had our differences on various subjects, but when it came to the subject of Israel, there was never a disagreement. Every one of us knew that we would all be accountable on the Day of Judgment for our silence. It was the most distressing thought. That's because we all knew that what the majority of people were doing about Palestine – in terms of protests, speeches, writing letters to their senators and the likes – was in no

way going to physically form an army to remove the Jewish state with an iron fist. Sometimes when I attended those protests, I would think about what the person next to me actually thought about in regards to picking up arms ... was that individual blind to this solution or did they honestly believe that their yelling and shouting was going to make the Israeli state disappear into thin air?

As time passed on, eventually talking became aching. When people brought up the subjects I used to explode upon, I would find myself exceptionally quiet. It was because I felt a deep sense of utter hypocrisy for just being a talker. I would tell myself that it's no longer worth it. I don't need to prove my views to anyone; I just needed to be a part of a cause that was changing the world stage. If one knows that he has the ability to fight for the Sake of Allāh, then nothing should stop him. It's like knowing that you're a bird, yet you never flap your wings to fly. Instead, you remain as a chatterer who talks about the wings and how great they are; but you are not serious about taking it upon yourself to fly. When that realization kicks in, that's when you start to grasp your actual worth. The next step from thereon is to test yourself in seeing if whether or not you were truthful in your claim. This becomes hard for those who continuously worry about the consequences in this world more than the consequences of the next.

I remember those moments when I used to stare at my computer monitor in sorrow watching endless hours of the plight of our Palestinian people. I still remember when my mother would come into my room and see me either near tears or extremely upset and ask me, "Why do you watch these videos? They only make you more sad!" May Allāh bless her; she always wanted her children to be in a joyful state. I would tell her, "I want to be upset [at the Israeli's]. The more upset I get,

the more I want to do something practical for the Ummah." She couldn't understand my mentality; when I would drag her to watch a few seconds of a depressing clip from Palestine – such as the young girl who saw the aftermath of her entire family slaughtered on a Palestinian beach – her question was always towards why I would watch such mind-shattering clips if I already knew what was going on. I told her frankly, "These clips remind me of the reality of what is happening in Palestine. I may know what's going on there, but I want my heart to be a part of it. If I disconnect my soul from their plight, by turning my face away from their sufferings, then I become like everyone else: Do nothing but hope."

I was not in search of grief or sorrow; nor was I hoping to achieve a state of constant sorrowfulness. Our religion does not permit this. Rather, I was attempting to be true to my Lord and myself on the plight of our nation. I wanted to shed those tears so that I would feel guilty not doing anything about our nation's dilemma.

I was upset with myself for the fact that I wasn't that attached to the Palestinian plight before. Before, I was only interested in establishing a caliphate, following an Islamic organization's guidelines on how to do so in a legal and peaceful manner! Where are the minds of our Muslims? Apparently it's in some gutter filled with other people that seek the protection of their own lives more than the protection of those that are being tyrannized by terrorizing weapons.

It doesn't matter who you are. If you are aware that the Israelis have been oppressing and repressing the Palestinians since 1947, then that guilty conscience kicks in. But for most of us, it's short-lived and we get on with our lives. It can be likened to the scene in the movie Hotel Rwanda where the journalist tells the hotel manager about how the world would react to the genocide: "They'll say, 'Oh my God that's horrible,' and then go on eating their dinners."

In America, I would constantly remember from my readings on Salāhuddīn Ayyūbi how he wouldn't even laugh with his brothers; this wasn't because he was harsh hearted or cruel. Rather, it was because his heart was soaked from the ocean of his guilty consciousness of,



'What am I going to do about it?' In other words, how can you live as a practicing Muslim and let this happen. A true Muslim, like Salāhuddīn, would stand up in the tide of blind followers.

Today, most of our scholars and leaders do not want us to be as such since Islam "is not hard". Had someone had said that to Salāhuddīn during the Crusader occupation of Palestine, he would of course turned his head away honorably and continued to work hard towards his goal no matter what the people said, *«Not fearing the blame of the blamers»* [5: 54]. Most of our scholars today are like the ones during his time who forfeited the battlefield after hearing about the large size of the Crusader enemy. Salāhuddīn didn't need them, but needed Allāh. Later, it was revealed that most of the Crusader army



disbanded, and its chief leader killed in an accident. The Crusaders had no chance against the Muslim army. Today, our scholars forfeit the battlefields around the world due to the fear of the enemy's size and superiority. But to everyone's surprise, it's the Mujahideen who have the upper hand. How many times have the Mujahideen witnessed the friendly fires amongst the enemy ranks? How many times have the Mujahideen witnessed earth shattering missiles that didn't leave even a scratch on their bodies?! How many times have the Mujahideen brought despair and destruction to the enemy with just one martyrdom seeker? The miracles that we witness on the ground are spectacular and truly send us the message that Allāh is on our side as He is a Witness to our sincerity of the Islamic cause.

We all know that without America's financial support for Israel, Israel would simply not be in the powerful state that it is in today. As a Muslim, I couldn't live with the fact that my tax dollars were going to Israel to kill my own kind. Forget that, I couldn't even live with the fact that I was residing under the greatest enemy today – the one who finances tyrants

and launches wars of injustice in the name of protecting its 'freedom' – and live like everyone else. I would always tell myself that if I were to get 'settled down' in America, with a family, well-off job, beautiful home and car and whatnot, then I would have lost my soul and have committed something much worse than suicide:



I would be burying the truth with every tool in the book, so that I could live a life of relaxation whilst allowing the Israeli tyranny continue.

For me, it was either *Hijrah* to the land of Jihād or Jihād in America. I could never picture myself doing something else than either of those. There really is no good to life when we see the Israelis bulldoze homes, rape chaste women, kill children with tank shells, drop phosphorous bombs on children schools, openly insult the Islamic religion, murder journalists in the broad daylight, drop groups of missiles on women who take refuge in their homes, murder innocent activists and tear apart bodies with rapid fire bullets. I cannot live with myself knowing this and turning out like the majority of the Muslims who turned their back on Jihād; I refuse to die as a 'normal' person who has a greater chance of entering the Hell than the Mujāhid who aspires to be a *shaheed*.

So where is your heart in all this? Are you ready to take that chance ... take the chance of dying a 'normal' death, empty of Jihād and sacrifice? Do you actually consider yourself to be of those who worry about their status on the Day of Judgment? Didn't the Prophet ﷺ speak of the *shaheed* with high respect and desire?

Ask yourself the question: Who is going to stop the Israeli oppression? The UN? America? A few protests around the world? A few letters to the senators? A few fiery speeches? Or is it going to be an honorable organized *mujāhid* vanguard, returning Islam to the rulership of the Muslim lands, seeking only the Pleasure of Allāh? You can either dishonor yourself by ignoring the reproaching guilty conscience, or you can answer it, joining the long list of noble Muslims that threw their bodies into the valleys of death in the quest of seeking the Face of their Lord.

Sheikh Ibrāhīm Ar-Rubaysh

THE CRUSADE AND THE SWAP OF STANCES

When you want to fight your enemy while you realize the material difference between your strength and his, certainly you need a strong will to take the decision of declaring war. However, after you have cut a long way into the war, and you see your enemy in a position of taking decisions similar to yours before declaring the war, you will be happy and thank Allāh Who gave you *tawfeeq* to take the decision of war.

Actually, this was my feeling when I was watching Obama proclaiming that Al-Qāeda is 'decimated' and is on 'its path to defeat'. These declarations from this failure reminded me of the Ummah's condition before the Battles of New York and Washington, and before Nairobi, Dar-Es-Salaam and Aden. At that period, the Ummah was being killed and expelled worldwide, and Muslims were contented with mourning on pulpits and condemning in the media. The enemy was disposing our affairs, killing, snatching honors, expelling and starving Muslims, and our suffering changed nothing on the ground.

Presently, the crusader enemy is in the same condition we were in before the war. On the media, you hear Obama's statement on Al-Qāeda's defeat, at the same time you see America evacuating around twenty of her embassies out of fear of mere communication claims between Al-Qāeda leaders, a bomb alert in its consulate in Milan and an emergency landing made by an American plane out of suspicion of a bomb. All this and Al-Qāeda is on its path to defeat! How would things be if it was on its path to victory?

This reminds me of the words of brother 'Ali Hamza Bahlūl, one of the prisoners in Guantanamo Bay - may Allāh hasten their release. This brother was talking with a detective on the Battles of New York and Washington. In the course of their conversation the detective asked him, "Did Al-Qāeda expect America's reaction to be of this scale?" The brother answered, "Previously, America was making events and Muslims were the ones to react. As for now, by simply swapping to making events and America reacting, it is a great victory." Indeed, most of America's action lately are either retreating or preparation to retreat.

Lately, Obama has been deceived by the intensification of the usage of drones. And he thinks he is putting an end to this war. This deceived guy has forgotten that the war between us is not ceased in this way. If we remember, all types of planes and soldiers were deployed in Irāq, they killed a lot of people - only their Creator knows the exact statistics. In the end, the enemy was forced to retreat, pulling the tails of defeat behind him plus debts which drain the blood of the concussed treasury. On the other hand, the Mujahideen are strengthening day by day. So what will a remote controlled plane achieve?

The war between Muslims and their enemy is not won by the number of casualties. Instead it is won by strengthening from Allāh and a strong will that is shaped by sacrifice. By the steadfastness of this will, the successors continue with their cause in a continuous series until victory is attained.

The unmanned drones propel the Jihād against the crusaders. They make the issue clearer to Muslims. They drive them to take on the path of Jihād. While Obama thinks he is killing Al-Qāeda, he is actually building an army which he will fight against eventually.

Obama is like a very thirsty patient that suffers from high blood pressure. As he becomes thirstier he finds a cup of salty water with salt crystals visible. To make the water drinkable, he has to get rid of the salt. So he stirs the water. As he stirs, the salt begins to disappear, this makes him very happy. So he stirs until the salt totally disappears. Yes, the salt disappeared from sight, but the taste of the water became saltier. This is exactly what Obama is doing by the use of unmanned drones.

With time Al-Qāeda may disappear. Not that Jihād has ceased, but the whole Ummah will be waging Jihād. Every Muslim will see that it is his obligation to fight with all his power against America. Just like when he hears the *adhān* he makes *wudhū* and goes to the nearest *Jama'ah*, if he does not find *Jama'ah* he prays alone wherever he is. The same way when he hears the call of Jihād against America, he will strive to answer it by joining the nearest Jihādi group. And if he does not find any, he will wage Jihād alone wherever he is. Thereupon, America will not only fear the Afghāni soldiers, but she will also be haunted by fear wherever her interests are. She will also fear the homegrown Muslims, and even American reverts. Everyone of those will be considered a time bomb which may blow up anytime, during a soccer game, a car race, or in a club.

Thereupon, the American people will curse their politicians who have dragged them into this hell. And the politicians will curse their consultants who deceived them that their empire will die together with history. When every people curses the other, Muslims will establish their Islamic structure. They will dispose their own affairs, and worship their Lord as He had ordered them to.



In Hot Pursuit of Mirage

Drones: Firing or Backfiring?

- **Jeremy Scahill, American Investigative Journalist and Author Democracy NOW!**

It seems that the drone strikes are hitting in areas where they are killing civilians. And what it's doing is turning people in Yemen, that might not be disposed having anything against the United States, into potential enemies that have legitimate grudge against America. We saw that repeatedly.

- **Nabeel Khoury, Former US Diplomat in Yemen Cairo Review of Global Affairs**

Given Yemen's tribal structure, the U.S. generates roughly forty to sixty new enemies for every AQAP operative killed by drones. Open source reporting records 45 drone strikes in Yemen in 2012, and 22 so far in 2013. Reported casualties are 491 for 2012. In war, unmanned aircraft may be a necessary part of a comprehensive military strategy. In a country where we are not at war, however, drones become part of our foreign policy, dominating it altogether, to the detriment of both our security and political goals.

- **Stanley McChrystal, Retired 4-Star General in the US Army HUFF POST**

What scares me about drone strikes is how they are perceived around the world. The resentment created by American use of unmanned strikes ... is much greater than the average American appreciates. They are hated on a visceral level, even by people who've never seen one or seen the effects of one."

- **Late Ibrāhīm Muthanā, Yemeni Writer and Activist The Guardian**

Rather than winning the hearts and minds of Yemeni civilians, America is alienating them by killing their relatives and friends. ... Certainly, there may be short-term military gains from killing militant leaders in these strikes, but they are minuscule compared with the long-term damage the drone program is causing. A new generation of leaders is spontaneously emerging in furious retaliation to attacks on their territories and tribes.

- **Barbara Bodine, Former US Ambassador to Yemen Yemen Policy Initiative**

However, the increased reliance on drones undermines our long-term interest in a stable, secure, and sustainable partner in Yemen. A growing body of research indicates that civilian casualties and material damage from drone strikes discredit the central government and engender resentment towards the United States. Where drone strikes have hit civilians, news reports and first-hand accounts increasingly indicate that affected families and villages are demonstrating and chanting against the Yemeni and US government.

- **The Economist, International Affairs Publication The state of Al-Qāeda - The Unquenchable Fire**

Given the fragility of the new Yemeni government of Abdo Rabbu Mansour Hadi, an army that is split into factions and fears that civilian casualties in drone strikes are driving the local population into the arms of the jihadists, AQAP looks able to maintain its special place in Al-Qāeda.

- **Alexander Meleagrou-Hitchens, CT Expert The International Center for the Study of Radicalization**

Drones will always be an easy way for [organizations like Al-Qāeda] to gain anti-American support. When something like a drone strike comes crashing down in people's front bedrooms or front rooms, that's going to help you recruit and radicalize, absolutely.

- **Micah Zenko, Council on Foreign Relations Member The Drone Debate Upends DC's Right/Left Divide**

There is also a strong correlation between targeted killings in Yemen since December 2009 - primarily conducted by U.S. drones - and increased anger toward the United States and sympathy or allegiance to AQAP. In 2010, the Obama administration described AQAP as "several hundred Al-Qāeda members"; two years later, it increased to "more than a thousand members." Now, AQAP has a "few thousand members." After a drone strike reportedly killed 13 civilians in early September, Yemeni activist Nasr Abdullah noted: "I would not be surprised if a hundred tribesmen joined the lines of Al-Qāeda as a result of the latest drone mistake."

- **Human Rights Watch, International NGO Between a drone and Al-Qāeda**

Should the United States continue targeted killings in Yemen without addressing the consequences of killing civilians and taking responsibility for unlawful deaths, it risks further angering many Yemenis and handing another recruiting card to AQAP. In response to these killings, AQAP has issued statements accusing the United States of fighting a war not just against Al-Qāeda but against all Muslims. Residents have set up roadblocks and held demonstrations in which they chant anti-US slogans.

City Wolves

■ Abdulilāh Shāye'
Free Lance Journalist

When Obama expressed his worries over a journalist, who had nothing but a pen and the truth regarding American crimes and lies, he made a confession. An official confession from the White House: America is breathing its last and the Jewish gangs running the country and the West are giving up on them. His way of expressing his worries demands cogitation; he picked up the presidential phone to make an urgent call to one of the mercenaries of his with the status 'President of Yemen'.

Being worried is a condition expressing fear. And disregarding diplomatic customs, by addressing a mercenary in a direct way, is a new problem in the history the presidents of America, a country that was built on the foundation stone of – as its constitution states: All men are created equal, with equal rights under the law that shall not be denied or abridged."

As the president of a country controlling the media run by capitalist companies, he was capable of directing the State Department or the CIA to notify their agents and mercenaries in Yemen of his desires. It is not unusual for them to obey. There was no need for him to pick up the phone and address another country's president personally, and give a direct order to place a journalist in a solitary cell for more than three years.

The American president's resort to that is a clear evidence of the condition of fear and - at the same time - of weakness. The truth is ripping through the façade and expose the real face of falsity and evil hidden by America and the West and the Jewish gangs that rule and dominate both of them.

As the journalist, whose pen and words worry Obama, is spending his time in a solitary cell by Obama's order, there were a number of wolves terrorizing Obama and threatening America's peace and security. They presented to the world evidences that America will be something of history in next to no time.

José Mante:

On the 21st of October, three weeks after the killing of Imām Anwar Al-'Awlaki, a New Yorker at the spring of his youth, 27, prepared three bombs in the kitchen of his mom. He followed instructions from a hand bomb making manual which turn rudimentary materials into high explosive ones. The manual could cause thousands of deaths and injuries. It was published by an English magazine produced by a Muslim Ummah's youth vanguard supervised by Sheikh Anwar Al-'Awlaki and spread through the internet.

Shāye', a Yemeni journalist spent three years in a Yemeni solitary cell for exposing the American massacre of 45 women and children in southern Yemen. lately Subsequent to his release, Obama expressed his concern over his freedom.

José Mante reverted to Islam less than a year before the incident. He is of Dominican origin, just like the American president is of Kenyan origin. But Khosieah Mantieh preferred the Islamic brotherhood bond as a community with an agreement of allegiance between all of its members. It is incumbent upon Muslims to support each other on the basis of religion, and not race, color or language.

José chose three military targets for the three bombs prepared in the kitchen of his mom, using instructions from Inspire. The operation was not carried out. And he was not connected with any group or foreign mentor. He was only connected to the Holy Qurān that taught him, «Indeed, believers are brothers» and «The believers are helpers and supporters of one another» The FBI arrested him. They failed to reach any connection with the vanguard of Muslim Ummah's Youth, Qā'idatul Jihād Organization; none of its branches.

Major Nidāl Hassan

Before José Mante, there was Major Nidāl Hassan. He killed and injured more than sixty officers, associates in the largest military base, Fort Hood, Texas. His reasons and motives did not differ from those of José Mante and Imām Anwar Al-'Awlaki. He was devoted to perform the Imām obligation of fighting evil in the world and supporting Muslims around the globe. Nidāl Hassan found out that his fellow officers and soldiers were perpetrating crimes against humanity in Afghānistān and Irāq. I got a copy of emails exchanged between Imām Anwar and him. They were given to me by the late Imām Anwar himself from his computer. He explained to me how they communicated.

Nidāl Hassan contacted Imām Anwar from Fort Hood itself. He said in one of his emails, "Don't you see what they do with our brothers in Palestine using American support? Why don't we carry out similar actions, support our brothers like they support the Jews in Palestine?!"

In another letter, he wrote: "Americans are carrying out inhumane operations, homicides, infringement of our brothers' rights in Irāq and Afghānistān . . ."

This Iman brotherhood bond is the same bond that inspired José Mante. This is what Imām Anwar Al-'Awlaki focused on its clarification by the Holy Qurān. Imām Anwar graduated from Colorado State University. He was a citizen, and he lived on the US West Coast in San Diego and on the East Coast in the Washington Metropolitan Area.

Jawhar Tsarnaev:

As the British journalist, Iona Craig, and the American journalist, Jeremy Scahill, were discussing ways of spreading the reality of Obama's orders that brought about my imprisonment in a solitary cell for three years, there were two brothers in the historic city of Boston preparing bombs in the kitchen of their mom. They used instructions from the English magazine, Inspire. They had the same motives and reasons: adherence to the bond of Imān and Islamic brotherhood that exists among Muslims through supporting each other against an enemy assaulting them, their land and wealth and killing their women and children in different parts of the world.

The Boston operation took place on April 14th, the anniversary of the beginning of the American Revolutionary War, a century after the sinking of RMS Titanic that left the British shores setting sail for the new world, the discovered land (America). Titanic sank after it struck a small piece of ice that led to its destruction. The story of Titanic is symbolic. It symbolizes America from its beginning to the end. The titanic ship represents the story of social classes, racism, greed, savagery by which America was founded, and the blood which it sucked to develop for four centuries.

The operation of the two Tsarnaev brothers in Boston has symbolic importance too; this is the city from whence the first sparks of independence erupted. The target that was chosen was a marathon and on the finish line. Sending the message that today America is on the finish line. There is no need of Bin Lāden's leadership or Al-'Awlaki's charisma for its destruction and placing it on the finish line. Because Jawhar Tsarnaev, a 19 year old young man, had already achieved that by just preparing a bomb in the kitchen, using kitchen utensils.

On September 11, America was at its pinnacle. So it took years of planning under a central leadership led by Bin Lāden, and 19 young men were needed to place America on the finish line. But the Boston operation, only a 19 year old boy was needed to destroy America and place it on that line.

Before them Feisal Shahzād, a son of a Pakistāni Intelligence officer, instigated a serious threat on Times Square on May 2010. Information indicates that he received training in the tribal region of Pakistān.

America with its unmanned drones was unable to prevent these threats; they have started to advance from within. And the city wolves are increasing in a way that portrays for us the future of America. America is sinking in debt crises as a result of the September 11 attacks and its sisters that exhausted it in illusionary wars borne by the tax payers.

And when a journalist strived to reveal the truth to the American and Western public, Obama and the Jewish gangs who run capitalism in America and hold the reins of wealth, politics and media became scared. Their fear reached the level of terror to the extent Obama picked up the phone to give his orders to place a journalist in a solitary cell. He believed by so doing he has placed the truth behind bars.





WHY DID I CHOOSE AL QAEDA?

SHAYKH ABU MUS'AB AL-AWLAKI

TODAY'S REASON

BECAUSE THEY TERRORIZE THE ENEMIES OF ALLAH

Among the things Allāh has bestowed upon Al-Qāeda and other Mujahideen, is that they terrorize the enemies of Allāh. Not all of this Ummah terrorize the enemies of Allāh.

He who terrorizes 'the enemies of Allāh' complies with the divine order of *I'dād* (preparation and training) and Jihād, Allāh says: *«And prepare against them your strength to the utmost of your power, including steeds of war, to strike terror into (the hearts of) the enemies of Allāh and your enemies, and others besides whom you may not know but whom Allāh knows. Whatever you shall spend in the cause of Allāh shall be repaid unto you and you shall not be treated unjustly»* [8: 60]

He who does not comply with this divine order, *I'dād* and Jihād, has no share in the terrorizing of the enemies of Allāh.

Inflicting terror on the enemies of Allāh moves you closer to Him. Ibn Katheer - may Allāh have mercy on him - said: "His word '*turhibūna*' to strike terror on the enemies of Allāh and your enemies' i.e. among the *kuffār*." *Tafsīr Ibn Kathīr*.

Indeed, whoever abandons *I'dād*, Jihād and the consolidation of the

'Aqeedah of *Al-Walā Wal Barā* (alliance and disavowal) and calls for counter-terrorism conferences and negotiation with the Jews, Christians and others, is among the people of the alleged moderation as per the hypocrites' dictionary. And as for he who follows the Orders of Allāh to his capability by terrorizing the enemy is a terrorist, a militant extremist and a radical. We say: Terrorism has been prescribed against the enemies of Allāh by the text of the aforementioned verse.

Congratulations to you, O Mujahideen, for the terror you have inflicted on the enemies of Allāh! How many plans have you made them refrain from executing? And if Allāh did not use you, the crimes of the Americans and their supporters would have increased, so would have their violation of the honor of Muslims and their money. Your terror is a pious act drawing you closer to Allāh.

How could we not like those who terrorize the enemies of Allāh? How could we not pursue the path of

those who make them (*kuffār*) panic and terrorize them as they terrorize Muslims?

Listen to the Amir of the 'Islamic State of Iraq', Sheikh Abū 'Omar Al-Qurashi Al-Baghdādi - may Allāh accept him, as he addressed his soldiers, a speech which terrorizes the enemies of Allāh. He said: "Erupt the volcano of anger. Burn the ground under the feet of the Jews and their supporters, wipe out their armies, destroy their vehicles, shoot down their planes, and prepare for them each and every ambush, ambush them in their homes, valleys and corners. Make your nights a cover (for you), change their days to fire. Grill their flesh by car bombs, cut off

their limbs by mines and take off their hearts by inflicting panic with snipers."

How much love to hear

these speeches from hundreds and thousands of this Ummah's leaders? Don't you know that because of our abandoning of Jihād we live in humiliation and shame.

Al-Qāeda is terrorizing the enemies of Allāh; the Jews, the Christians, the apostates and others.

Know that Al-Qāeda's terrorism is against all who show enmity towards Islam. It is not essential for the enemy of Islam to have blue eyes or yellow skin!! Al-Qāeda is terrorizing the enemies of Allāh; the Jews, the Christians, the apostates and others. Anyone who follows the media and is aware of their movements knows how Allāh has filled their hearts with the fear of Al-Qāeda, which is fighting the enemies of Allāh, whether he is a Western infidel or an Arab apostate.

Sheikh Abū Mus'ab al-Zarqāwi - may Allāh accept him - said: "The time has passed for the Ummah to accept to suckle humiliation and shame. The time has passed for its promising dawn to be occupied by the hands of the hypocrites of our compatriots. In the last century, the nation sacrificed the precious and expensive, and fought and waged Jihād against the infidel occupier. With our Ummah in a deep heedlessness, unenviable naivety, it allowed the opportunistic *munāfiqīn* to take over the helm of power, and hold leadership positions. They did to the people of Islam what

the foreign infidel was unable to do a hundredth of. This bitter experience is still present in our minds. It is still clear before our eyes. And we will not allow it to happen again, *biidhnillāh*. Your righteous sons have revived - *bihamdillāh* - the jurisprudence of our righteous predecessors of fighting the sects of apostasy, and the application of the Rule of Allāh on the apostates and the *mumtani'īn* (abstainers) from the Laws of Allāh. Our Jihād will continue, without differentiating between the Western infidel and the Arab apostate until *Khilāfah* resurfaces on Earth, or we die for that purpose."

Do you like to hear these words directed to the enemies; Americans and the apostates? Or do you like to

hear the words of those who say that these *tawāghīt* rulers are not *kuffār*, but *wulātu umūrinā* (the governors of our issues)!! Which of these two terrorizes the enemies of Allāh?

It should be noted, that the conferences called 'counter-terrorism conferences', which are attended by some scholars, are not allowed to attend to, even if the intention of some of the scholars may be good. Because if a Muslim and a *kāfir* agree on a word, while the Muslim has good intention and the *kāfir* has a bad intention, their agreement should not be regarded. The word should be changed to another which has no gateway for them. This is indicated by the fact that Allāh has forbidden the believers to say, 'ra'inā', so as not to agree with the Jews. The Jews used this word to mean 'ra'unah' (negative meaning). Allāh the Almighty says: *«O you who believe! Say not (to the Messenger of Allāh ﷺ) 'ra'ina' but say 'undurnā' (make*

us understand) and for the disbelievers there is a painful torment» [2: 104]

The term 'terrorism' is meant by Americans and the *Munāfiqīn*

to be Jihād, while some scholars intend another meaning, but they agreed on the word. Basing on that, it is not permissible to attend the so-called 'counter-terrorism conferences'. You should know: This term, which was brought by the Americans and their agents to attack Islam, did not come out of the blue. It came after they felt their hearts have been really terrified by the Mujahideen, they shouted out of fear of the sons of Islam through their own media. Congratulations to you, O Mujahideen! This is a great *'Ibādah!*

Being among a people who terrorizes the enemies of Allāh is dearer to me than being among a people who do not.

COVERT DEEDS

Love without Hate?

Many who claim to love Allāh, are far from following Sunnah, enjoying good and forbidding evil and Jihād in the Way of Allāh.

They claim that this way is more complete than other ways. They claim that loving Allāh does not require jealousy nor anger for the Sake of Allāh. This contradicts the method of the Qurān and Sunnah.¹

Given the fact that complete love requires concurrence with the loved one in regard to those he loves, hates, allies with and shows hostility, those who love Allāh should hate His enemies.

A heart filled with the Love of Allāh and His Messenger, requires allying with His allies, and showing hostility towards His enemies.²

«You (O Muhammad) will not find any people who believe in Allāh and the Last Day, making friendship with those who oppose Allāh and His Messenger (Muhammad), even though they were their fathers or their sons or their brothers or their kindred» [Mujadilah: 22]

«And had they believe in Allāh, and in the Prophet (Muhammad) and in what has been revealed to him, never would they have taken them (the disbelievers) as Auliyyaa (allies)» [Al-Ma'idah: 81] Therefore, this correlation is a necessity.³

1 - *Majmoo' Fatāwa* (10/ 83)

2 - *Majmoo' Fatāwa* (10/ 60)

3 - *Majmoo' Fatāwa* (7/ 645)

- Ibnu Taymiyyah

Conditions of the Word of Tawheed

■ Sheikh Hārith An-Nadhāry

This is the beginning of a new series in the Manhaj Review section, 'The Word of Tawheed' - Monotheism. The text is excerpted from the book, 'The Word of Tawheed' penned by Sheikh An-Nadhāry. We hope it will be of benefit to our readers.

The Word of Tawheed has conditions that should be fulfilled. These conditions are divided into two:

- Conditions for protecting one's blood in *dunyā*.
- Conditions for one's safety from the eternal life in Hell on the Day of Judgment.

Conditions for protecting one's blood in *dunyā*:

There are only two conditions:

1) The verbal pronouncement and acknowledgment of "*lā ilāha illallāh, Muhammadur rasūlullāh*" (There is none that has the right to be worshiped except Allāh and Muhammad is His Messenger.) Those who are unable to speak are exceptional in this condition.

It was reported by Abūhurairah - *radhiyallāhu 'anh*, that the Messenger of Allāh ﷺ said: "*I have been commanded to fight the people until they say 'lā ilāha illallāh'. Whoever says 'lā ilāha illallāh' his wealth and his life are protected from me except for a right that is due, and his reckoning will be with Allāh.*"

Ibn Taymiyyah - *rahimahullāh* - said, "If one does not pronounce the two *shahādah* (declarations) - during capability - he is a *kāfir* as per the consensus of the Muslims. He is a *kāfir* both inwardly and outwardly, to the *salaf* (righteous predecessors) of this Ummah, its *imāms* and the general consensus.

No deed can replace the two *shahādah* except *swalāh*. Imām Al-Qurtubi - *rahimahullāh* - said, "*Imān* is not achieved by - apart from "*lā ilāha illallāh*" - any deed nor saying except *swalāh*. Ishāq ibn Rāhaweyhi - *rahimahullāh* - said, "They all agreed in *swalāh* what they did not in the rest of *sharāi'* (forms of worship). Because they all said that whoever is known of *kufr* and seen praying on time a lot of *swalāh* - while he is known not to have declared (the two *shahādahs*) by tongue - is counted to have *Imān*. They did not include this in *saum* and *zakāh*."

2) Absence of committing one of the nullifiers of Tawheed. Whoever comes with the Word of Tawheed and commits one of the nullifiers of Tawheed, then fruitless is his work and he has departed from *Imān*; and in the Hereafter he will be among the losers. Allāh says, "*Whoever disbelieves in (i.e. denies) Allāh after his belief, except for one who is forced (to renounce his religion) while his heart is secure in faith. But those who (willingly) open their breasts to disbelief, upon them is wrath from Allāh, and for them is a great punishment; That is because they preferred the worldly life over the Hereafter and that Allāh does not guide the disbelieving people. Those are the ones over whose hearts and hearing and vision Allāh has sealed, and it is those who are the heedless. Assuredly, it is they, in the Hereafter, who will be the losers*" [16: 106 - 109]

Conditions for one's safety from the eternity life in Hell on the Day of Judgment.

These are several conditions. The precise number differs in accordance with dividing either in general or in detail. Among the scholars, there are those who counted them as seven, while others went beyond that. The summary of the conditions is as follows:

- *Al-'Ilm* (knowledge) of the meaning of "*lā ilāha illallāh*". The Almighty says, "*So know (o Muhammad) that none has the right to be worshiped except Allāh*" [47: 19]
- *Al-Yaqīn* (certainty); The one declaring the *shahādah* should be certain of its meaning. If he has doubt or suspicion of its meaning, it will not be of any benefit. Allāh says, "*The believers are only the ones who have believed in Allāh and His Messenger and then doubt not*" [49: 15]
- *Al-Qabūl* (acceptance) of what this Word denotes: worshiping Allāh Alone, leaving worshiping others apart from Him. And whosoever declares it and does not accept worshiping Him Alone falls in those Allāh informs about, "*Indeed they, when it was said to them, 'There is none that has the right to be worshiped except Allāh,' were arrogant. And were saying, 'Are we to leave our gods for a mad poet?'*" [41: 35 - 36]

- *Al-Inqīād* (compliance) with the indications of the Word of Tawheed. Allāh says, "*And whoever submits his face (self) to Allāh while he is a doer of good - then he has grasped the most trustworthy handhold*" [31: 22] The difference between *al-qabūl* and *al-inqīād* is that *al-qabūl* is from the deeds of the heart, while *al-inqīād* is a body deed. Hence, the first is done covertly while the second overtly.
- *As-Swidq* (truthfulness); One should say this Word truthfully from his heart. The Prophet ﷺ says: "*There is none who testifies truthfully from his heart that 'lā ilāha illallāh, Muhammadur rasūlullāh', except that Allāh will save him from the fire of Jahannam.*"
- *Al-Ikhlaas* (sincerity); Cleansing one's deeds from all types of *shirk*, the declaration should never be for the sake of worldly gain. The Prophet ﷺ says: "*Allāh has forbidden to the Fire everyone who says 'lā ilāha illallāh' seeking thereby the Face of Allāh.*"
- *Al-Mahabbah* (love) for this Word, what it indicates and those working for it. Allāh says, "*And of mankind are some who take (for worship) other besides Allāh rival (to Allāh), they love them as they love Allāh, but those who believe love Allāh more.*" [2: 165]



"We have an enemy that is 24/7 trying to find ways to kill us in many forms."

- Rep. Peter T. King



24/7 TERRORISM

■ Muhannad J. S.

A couple of months ago, I had a conversation with AQAP's military commander, Sheikh Qassim Ar-Reimy, on the ongoing conflict between the Mujahideen and America. I asked him: Why do you think the Americans fear Jihād and Mujahideen that much? "Because the Mujahideen follow the *manhaj* of the Prophet Muhammad ﷺ who said, "Allah made me victorious by terror (by His frightening my enemies) for a distance of one month's journey."¹ Therefore, any Muslim following the way of the Prophet ﷺ, will be feared by the enemies of Islam."

"We have an enemy that is 24/7 trying to find ways to kill us in many forms." This is the way Rep. Peter King² put the threat he feels posed by Al-Qāeda in the Arabian Peninsula (AQAP) to his country's homeland security. This statement was declared in a Subcommittee on Counterterrorism and Intelligence's (SoCI) hearing "Understanding the Threat to the Homeland from AQAP." It was held on September 18, 2013 in the House of Representatives, Washington, DC.

The significance of this hearing lies in both of its objectives and timing. It took place a week after the 12th anniversary of the September 11 attacks and a month after the closure of 22 American embassies and consulates in the Middle East and North Africa due to what America referred to as 'AQAP's imminent threat to US interests in the region'.

The hearing – according to King – had three purposes:

- Evaluating AQAP's intent and capability to attack the U.S.
- Reviewing the US counterterrorism policy towards the group.
- Reviewing the lessons learned from the August embassies closure.

Apart from King, four other participants took part in the session: (D) Brian Higgins, NY, member of the House Committee on Homeland Security, and three expert witnesses in the field of counterterrorism, Frank J. Cilluffo³, Katherine Zimmerman⁴ and Brian Katulis^{5,6}.

The outline of the hearing was explicit about:

1. The effectiveness of the strategy of the Mujahideen in the war against the U.S.
2. The failure of the strategy adopted by the American regime in countering Jihād.

AQAP between Capability and Threat

All the speakers expressed a common perspective on AQAP's intent and capability to attack America. They summarized their viewpoints in the following factors :

- "AQAP focused its efforts on the far war against the U.S., and during the last 4 years, AQAP has come to form the most direct terrorist threat to the U.S."
- "The group is also not afraid to attack the United States where it can, be it on the United States' soil, or our interests throughout the world."
- "AQAP poses the greatest threat to the U.S. homeland because it has directly targeted the U.S. homeland as well as U.S. interests abroad on multiple occasions."
- "AQAP has demonstrated and continues to demonstrate significant ability and intent to do harm to the U.S. and its interests."
- "The organization has invested significantly in encouraging radicalization and "lone wolf" homegrown attacks, including "Inspire" magazine. AQAP's efforts in this regard propagate the ideology that underpins Al-Qāeda as a movement, and provide the "how to" do-it-yourself in terrorist tactics, techniques, and procedures."
- "AQAP has sought to foment "lone wolf" attacks in the west via propaganda such as the English-language Inspire online magazine. And these kinds of attacks are hard to prevent."
- "The linkages between AQAP and other Al-Qāeda affiliates and terrorist groups are another source of

significant concern."

- "AQAP has improved its operational security and changed its practices; think tradecraft, communications, and planning."

All these points form an accurate indication that proves the Mujahideen's strategy of targeting the snake's head, 'America', has proved to be the best way to repel the enemy. This proof can be summarized by the following:

1. Achieving the 'balance of horror' in the ongoing conflict between Islam and kufr.
2. Putting the enemy under continuous pressure as a result of expecting sudden attacks, be it lone Jihād attacks in his backyard, or attacks on his interests out of the U.S. soil.
3. Placing the enemy in a defensive position and keeping him away from spreading hostilities on Muslims.
4. Forcing the enemy to spend more money on beefing up security measures inside and outside his borders; hence economic hemorrhage.
5. Prolonging the war, America's backbone cannot bear a long war (due to point 4)
6. Tightening the screws on the American people, as a result of excess security, will make them feel weary. Therefore, they will pressure their government to end its war against Islam and Muslims.

US Counter-Jihād Policy towards AQAP

All the participants agreed that the U.S. strategy in countering Jihād is failing and fruitless. The following points presented by the contributors demonstrate how so:

- "It is astonishing that even though the United States has eliminated much of their senior leadership and one of its most effective recruiters, the group can still have the capability to conduct attacks against the United States.

It also recognizes the economic devastation terrorist acts can bring."

- "Despite the elimination of Anwar Al-'Awlaki and Inspire editor-in-chief Samir Khan in a U.S. airstrike in September 2011, AQAP's desire to spread violence to the west by encouraging attacks by individuals heretofore unaffiliated with terrorist organizations remains."
- "Aside from Awlaki, more than 35 senior leaders of AQAP have been killed by drone strikes, yet the organization still continues to be a threat to the United States. AQAP moves fast and recognizes targets and opportunities for recruitment and exposure."
- "The strategy to disrupting the Al-Qāeda network by killing senior leadership has been ineffective in dismantling the network overall."
- "More than a decade after the September 11 attacks transformed the way we as a nation view these threats, the U.S. still lacks the overall ability to assess strategically whether the government is properly matching resources to meet the threats posed by these various terrorist networks."
- "The department of Homeland Security does not recognize the Buffalo-Niagara region as a high-risk area. Hence, local law enforcement in the Buffalo-Niagara region is left without the resources that could possibly be needed if an attack from this dangerous organization where to occur."
- "The U.S. counterterrorism efforts to respond to the threats posed by AQAP in Yemen is a prime example of a series of tactical efforts producing some successes and some failures, but all of these efforts are nested in a weak overarching strategy lacking sufficient focus on the long-term investments necessary to help produce sustainable security."

- "The strategy to counter AQAP relies on American direct action operations targeting AQAP leadership and on Yemeni counterterrorism operations to combat the group on the ground. It is not clear that this strategy will be effective against AQAP"

Therefore, after more than a decade of waging a vicious global war on Islam, wasting billions of dollars, and giving away tens of thousands of killed and injured, the American counter Jihād experts have found out, surprisingly, that their ruling regime has been playing wrongly and losing the war on the ground through 'faulty understanding, failures and ineffectiveness!'

From a Jihādi point of view, these failures of the American strategy add more dimensions to the current warfare:

- The policies of the American direct and indirect occupation have not guaranteed victory or security to Washington so far, nor do they seem they will in the future.
- As a result of the unexpected reversed outcome of the 12 years crusade, the American regime has taken a defensive position and adopted 'damage control' policy. This attitude make all the counter Jihād plans of the regime weak and inoperative.
- The targeted killing strategy executed by drones has not repressed the Mujahideen from achieving additional expansion and adherence within the Muslim Ummah. On the contrary, it grants them more support and strength on the ground.
- The killing of the Jihādi leaders by American drones has not changed the Mujahideen's strategy of targeting the empire of tyranny in its heart or halted their projects to inspire the Ummah to do the same.

"AQAP has demonstrated and continues to demonstrate significant ability and intent to do harm to the U.S. and its interests."

words, number of times mentioned in the hearing:

Lone Wolf = 5

Inspire = 7

Inspire Magazine = 12

Homegrown = 7

- Despite of an increase in America's reliance on local agent armies to face the Mujahideen in frontlines, as an attempt to take the battle's heat off its soldiers, the recent attacks on these armies – particularly in Pakistan and Yemen – revealed that this strategy is unproductive.
- The US domestic security system has many obvious gaps that need to be put on the priority of the Mujahideen's attack list.
- The war between Islam and kufr is about patience. The Muslim Ummah and its Jihādi front have no problem to keep fighting America for centuries, but America is not ready to do the same.

Dead End

The witnesses of the hearing suggested some solutions to save the U.S. regime from its dilemma, especially in the light of the complications it faces in Syria and the approaching American retreat from Afghanistan.

The solutions mainly focused on two options:

1. The U.S. needs to conduct a broader more coherent policy to promote Yemen's transition to democracy under President Abdo Rabu Mansour Hadi in order to have a more effective long-term policy that can eliminate AQAP.

OR...

2. Instead of waiting till the Mujahideen's threat emanates and is in front of the U.S., it is better to use 'suppressive fire' to keep AQAP looking a little bit over its shoulder, so that it has less time to plot, train, and execute attacks.

If these two options come from the extract of America's elite minds in the field of counter Jihād, I have to say the American people should be ashamed, because those 'experts' know nothing about reality and history. Why so?

1. Sahih Al-Bukhari. The Book of Tayammum, Hadith no. 335.
2. Rep. Peter T. King (R-NY), Chairman of Subcommittee on Counterterrorism and Intelligence (SoCI) in the U.S House of Representatives.
3. Associate Vice President Director, Homeland Security Policy Institute. The George Washington University.
4. Senior Analyst, Critical Threats Project, The American Enterprise Institute.
5. Senior Fellow. Center for American Progress.
6. For further details, refer to the complete session on the web.

Reality tells us that the democratic solution is the worst idea ever to be implemented on a Muslim environment, essentially for two reasons:

- Democracy is a contrary idea of Tawheed (Monotheism), because it calls to shirk of masses' ruling instead of worshipping Allah (swt) Alone in legislation and ruling by Sharia law.
- Democracy proved its failure as a theory and a system in the Muslim communities. And what the whole world witnessed in the recent months in Egypt, Libya, and Tunisia is a concrete evidence.

History shows that the usage of military force in any war - not battle - between Muslims and kuffar, failed to finish the war in favor of the kuffar. The nine historical crusades, the Soviet's invasion of Afghānistān and the American invasion of Irāq all ended with humiliating defeats on the infidels' side, by the Grace of Allāh. Therefore, using 'suppressive fire' is not a brilliant idea either.

The SoCI's hearing on AQAP's threat to the U.S. homeland security presented plenty of important facts about the deep nature of the combat between Islam and kufr. The war in its real essence and meaning is not about Al-Qāeda and America; it is between Tawheed and shirk, belief and disbelief. This is what it is about all the time, and this what it will be until the very end of this universe.

As for America, it has definitely lost the war on Islam, and it is only a matter of time, *insha' Allah*, until it pulls all its troops from all the Muslim countries and vanishes behind the Atlantic licking its wounds and recalling its bitter memories in the Muslim lands.

The Good, the Lamb and the Ugly

■ Abu Nûh

Not so long ago, in the mysterious land of survival of the fittest, there lived an ugly wolf hybrid known as Wolfdog. Among his peers, he was distinguished by his big head, a long tongue and a loud howl. Hence, he became the alpha male in his pack.

One day, as Wolfdog was on a hilltop searching for a refill for his rumbling stomach, he saw a young lamb with fluffy wool playing in a grassy glade. Wolfdog climbed down the hill to 'meet' the charming little lamb, resolved not to lay violent hands on him, but to find some plea to justify to the Lamb his right to eat him. He thus addressed him: "Kid, last year you grossly insulted me." "Indeed," bleated the Lamb in a mournful tone of voice, "I was not then born." Then said Wolfdog, "You feed in my pasture." "No, good sir," replied the Lamb, "I have not yet tasted grass." Again said the Wolf, "You drink of my well." "No!" Exclaimed the Lamb, "I never yet drank water, for as yet my mother's milk is both food and drink to me."

"Well! I won't remain supperless," thought he. He seized him and ate him up, saying, "So it must have been your mother!"

The Mother powerlessly followed the dialogue. What could this poor mother do when she saw her beloved son being torn into pieces between the teeth of the wolf? She knew she could not reclaim her right, but in the passion of motherhood, this good mother butted Wolfdog. Of course the wolf was not affected at all. But he became very furious, his pupils dilated. He raised the base of his tail. "How dare this ewe touch me!" Thought he.

He howled with a long, smooth sound, "This is a terrorist! This is a terrorist!" All other wolves howled, repeating Wolfdog's words, creating an illusion that there were many condemning the act of the ewe. It is not strange that these howls were heard from 10 miles away, but the strange thing is how these howls echoed throughout the forest. Whereby the parrots joined in and repeated what Wolfdog said, saying, "We condemn the ewe's butt against the wolf, all the animals are against this barbaric act!"

THE JIHADI EXPERIENCES

THE CONCEPT OF PREPARATION, ITS CAUSE AND GOAL

SHEIKH ABU MUS'AB AL-SURI

Preparation (for Jihād) means familiarity with the collection of knowledge, sciences, learned and physical skills, in order to carry out the mission of Jihād. It is combat in the Way of Allāh. Its concepts, means, and goals have been summarized in these two holy verses.

On this [theme of preparation] there have been so many elaborations of Sunnah texts, both words and deeds, that the theme warrants a whole book.

Here, for the purpose of brevity, [we present] two Qur'ānic verses: Allāh the Almighty says: *«Against them make ready your strength to the utmost of your power, including steeds of war, to strike terror into (the hearts of) the enemies of Allāh and your enemies, and other besides whom you may not know, but whom Allāh knows. Whatever you shall spend in the cause of Allāh shall be repaid unto you, and you shall not be treated unjustly.»* [Al-Anfāl: 60]

And in the Qur'ānic verse: *«And if they had wished to go forth they would assuredly have made ready some equipment, but Allāh was averse to their being sent forth and held them back and it was said (unto them): Sit with the sedentary!»* [At-Tawbah: 46]

Let us note some of the benefits which these verses refer to:

As for the Al-Anfāl verse:

1. Establishes that preparation to your best capability, but not beyond your capability is a legal commandment. Every Muslim must prepare his strength and weapons as best he can.

2. Strength and steeds of war: This comprehensive term refers to all kinds of weapons, instruments of war and means for moving and transportation. Allāh's Messenger ﷺ has clarified this by saying, "Indeed, power is shooting," repeating it three times. The Qur'ān has ordered all Muslims to possess weapons and not to be negligent of them: *«Take all precaution, and bear arms: the disbelievers wish, if you were negligent of your arms and your baggage, to assault you in a single rush. But there is no blame on you if you put away your arms because of the inconvenience of rain or because you are ill; but take (every) precaution for yourselves. For the disbelievers, Allāh has prepared a humiliating punishment»* [An-Nisā': 102]

3. The verse clarifies that the duty of preparation is not merely to gain knowledge, to exercise, and other things like that. This is an idea which has spread recently, that preparation

is like going on a holiday without any intention to fight Jihād. Preparation has a specific goal ... 'make ready' ... 'to strike terror into (the hearts of) the enemies of Allāh and your enemies, and others besides. ...'

4. Then, after the command to prepare and possess weapons and instruments of war, the verse kindly points out that Allāh knows the cost of what was spent in His Cause, and that the wealth of most of those wishing to fight Jihād fails to reach this. Thus, as the verse closes with this command about spending, it promises a large recompense and grant from Allāh.

As for the At-Tawbah verse, it contains great instructions, and great jurisprudence regarding the relationship between preparation and faith, and its relationship with practical Jihād; some of its subtleties are:

1. The verse talks about the hypocrites who claim to have a desire for Jihād, after the previous verses have described the relationship of the faithful [to Jihād]. The faithful fight with their wealth and souls, and do not excuse themselves from the fight in order to flee, as the hypocrites do, whose hearts feel doubt, and who excuse themselves in order to flee. [This is why the At-Tawbah verse

has been called, 'The disgracer of the hypocrites']. The verse we cited above establishes that it is a sign of the hypocrites' hypocrisy that they turn away from preparation to battle and Jihād, and it says about them, *«If they had wished to go forth»*, or, if their resolution to fight and to go out [to do so] had been sincere, *«They would assuredly have made ready some equipment»*, or, they would have made necessary preparations for the battle, in accordance with their capacities and to their best ability.

2. It also establishes that Allāh, the Almighty and Supreme, was averse to their being sent forth to fight, and held them back because He knew their condition, and made them sit down, being merciful to the Mujahideen, because their going forth would create disorder and harm.

Let us return to our subject, which is the relationship between Jihād and 'preparation'. The verse points to the fact that the stages of this can be found in His words: *«And if they had wished to go forth they would assuredly have made ready some equipment, but Allāh was averse to their being sent forth and held them back and it was said (unto them): Sit with the sedentary!»* [at-Taubah: 46]

From the instructions in this verse, we understand that there are three stages: 'will' ... 'preparation' ... 'launch'. This dynamic logical order summarizes the operational mechanism in the performance of Jihād and Resistance. Will: the will to fight is a prerequisite for 'preparation', and then 'Jihād'.

All military schools agree that a will to fight and moral strength of the fighter is the basis for victory and good performance. Also, will is the basis for all actions and all aspects of human activity. Whoever desires food, drink, marriage, business, travel or anything else, requires the possession of the sincere will to start with. The proof of the sincerity of this will is that he makes the necessary preparations for that decision.

In our situation, which is Jihād ... preparation is the fruit of sincere will. When the will is sincere and the determination is firm, one starts making preparations according to his capabilities, in order to terrorize the enemies of Allāh and the Muslims. ... After the preparation, one is dispatched to the battle. ...

Thus, if the desire is sincere and the preparation is undertaken according to one's ability, the individual moves to launch Jihād unless Allāh the Almighty and Supreme has not held him back due to the disorder and harm [he would cause] - we pray to Allāh for His well-being and endurance - and unless he has not been taken control of by Satan or by his own inclinations due to cowardice and weakness, a motive which the Prophet Muhammad ﷺ described in short: "Love for the world and aversion of death."

This combat will is the incentive for preparation and activity. If it is very important and a basis for the regular soldier, then it is the fundament for the guerrilla fighter in general and the Jihādi Resistance fighter in particular. Even more, it is his basic weapon, which moves him to do whatever he is capable of, even using civilian weapons, if there is nothing else available.



Seif Al-'Utaybi preparing for his launch.

A person wearing a bright red hooded jacket is looking through a chain-link fence. The person is out of focus, and the background is a blurred outdoor setting with a blue sky and some structures. The fence is in sharp focus in the foreground, creating a sense of barrier and separation.

THE BARRIER BETWEEN

Cowardice¹ is the opposite of courage. Courage is the firmness of the heart. The heart is the essence of every good deed. The heart cannot be firm if the mind isn't sound. If the heart is weak, it leads to cowardice, and if the heart is too strong, it leads to recklessness.

The coward needs to cure cowardice by eliminating its causes. If it is caused by ignorance then ignorance is cured by learning. The cause could be fear of the unknown and that is cured by experiencing situations. We find that the beginner in public speaking experiences fear in the beginning but after experience, this fear is overcome. We find that when a person first meets a king they might fear the occasion and their tongue would be tied and their posture would change. That is due to the anxiety of facing a new experience. But if that occasion is repeated many times the fear is eliminated. Original nature can be changed. It is sufficient as proof to see a Hawachild (children trained to care for snakes) grabbing a large snake that would make a brave man tremble while this same child could fear a frog because he is not exposed to frogs. Taming animals is a process of changing their original nature and it is done through training. A wolf could play with a sheep, a cat with a mouse, and a dog with a cat, if they are conditioned to do so, even though that is contrary to their original nature. Now, if animals can change their characteristics can't humans do the same? Having a strong heart leads to victory. Ali (bin Abi Tālib) - may Allāh be pleased with him - was asked: How do you defeat your enemies? He said: When I would meet my enemy I would believe with firm conviction that I would defeat him while he too believes that I would defeat him, so both my self and his, support me against him. Some have advised: Believe in victory, you will be victorious. Others say: If you fear your enemy you have allowed an army to be sent against your heart. We have found that the ones who died because of their fear are more than the ones who died due to their courage.

1. Mashari'ul Ashwāq by Ibnu Nuhaas (martyred in the 15th century AD) - Translated by Sheikh Anwar Al-Awlaki



An Interview with **OBAMA**

■ Muhannad Jannah Seeker

This hypothetical interview with the White House gangster was carried out by a member of our team. It is important to note that all of Obama's answers are directly quoted from the counterterrorism speech he gave on 23rd May, 2013.

The main idea here is to focus on the change of the American tone regarding the zio-crusade war waged on the Muslim Ummah and its Jihadi front. This change comes after years of fighting and massive losses on the enemy's side to the extent that the American regime has realized it's too difficult to achieve victory in such a long ferocious war.

Q: To begin, do you believe your regime plays clean and fair in this war?

A: I believe we compromised our basic values by using torture to interrogate our enemies, and detaining individuals in a way that run counter to the rule of law.

Q: Don't you care about the Muslim civilians that American drones kill?

A: It is a hard fact that U.S. strikes have resulted in civilian casualties, a risk that exists in all wars. For the families of those civilians, no words or legal construct can justify their loss. For me, and those in my chain of command, these deaths will haunt us as long as we live, just as we are haunted by the civilian casualties that have occurred through conventional fighting in Afghānistān and Irāq.

Q: Al-Qāeda says that you are too coward to put boots on Muslim grounds; you cannot take a new defeat after what happened to your army in Irāq and Afghānistān. How true is this claim?

A: It is false to assert that putting boots on the ground is less likely to result in civilian deaths, or to create enemies in the Muslim world. The result would be more U.S. deaths, more Blackhawks down, more confrontations with local populations, and an inevitable mission creep in support of such raids that could easily escalate into new wars. So yes, the conflict with Al-Qāeda, like all armed conflicts, invites tragedy.

Q: Are you planning to utilize your 'well trained' Special Forces? Is there any worry that they may let your regime down like they did in the failed raid in Barawe, Somalia?

A: It is also not possible for America to simply deploy a team of Special Forces to capture every terrorist. And even when such an approach may be possible, there are places where it would pose profound risks to our troops and local civilians where a terrorist compound cannot be breached without triggering a firefight with surrounding tribal communities that pose no threat to us, or when putting U.S. boots on the ground may trigger a major international crisis.

Q: Why do you always avoid giving a clear pledge to defeat what you call 'terror'?

A: Neither I, nor any president, can promise the total defeat of terror.

Q: How do you assess the effect on the U.S. caused by the zio-crusade war you lead against Islam?

A: For over the last decade, our nation has spent well over a trillion dollars on war, exploding our deficits and constraining our ability to nation build here at home. Our service-members and their families have sacrificed far more on our behalf. Nearly 7,000 Americans have made the ultimate sacrifice. Many more have left a part of themselves on the battlefield, or brought the shadows of battle back home.

Q: Do you believe your vicious war against Islam and Muslims will end someday?

A: This war, like all wars, must end. That's what history advises. That is what our democracy demands.

Q: After over a decade of launching an expensive war and billions of dollars you have spent on beefing up security measures, does America still fear Jihadi attacks on its soil?

A: Our nation is still threatened by terrorists. From Benghazi to Boston, we have been tragically reminded of that truth.

Q: Finally, how much damage can a lone Mujahid do to harm America? Make your answer short. Your time is up.

A: U.S. citizens or legal residents can do enormous damage, particularly when inspired by larger notions of violent Jihad. That pull towards extremism appears to have led to the shooting at Fort Hood, and the bombing of the Boston Marathon.

MUJAHIDAH

wife of a

MUJAHID

■ Umm Yahya

“the number of righteous people should not bother you as long as you have played your part, the truth is divine and glorious and its people are few,,

O Mujāhidah! O *Ghareebah!* O who has preferred *ākhirah* over this *dunyā*. O beloved sister in Islam, the honorable wife of a Mujāhid and his best companion, all praise to the Almighty. *MashāAllāh*, you are different from the rest of the women. You are a Mujāhidah, just like your husband. You are a hero, and a Soldier of Allāh. And you possess a heart of an oak.

You have a great role, a great message in this chosen life. You are walking alongside your companion on a noble path, away from the corrupted western-dominated world. It is upon you o sister in Islam to understand the requirements of this path, its commitments, consequences and obstacles. While the Mujāhideen are the most blissful of people, Jihād is not a bed of roses; loss of wealth, part of friends and most of all, leaving your family and home. Your patience should be at the peak, so as not to allow desires to manipulate you. Always pray to Allāh this supplication, "*Yā Muqallibal qulūb wal absār, thabbit qulūbanā 'alā dīnik*" (O Lord, Changer of hearts and sight, make our hearts steadfast in your religion.)

Jihād is surrounded by hardships. Believe me, without them your life will be as flat as soda water standing in the sun. The utmost of things you will certainly encounter in your path with your companion is the rumors and falsehood that the media propagates regarding Jihād and its sons. Sadly enough, Muslims around you may believe and buy their stories. Thus it is upon you my sister, to be the reinforcement of truth against these false allegations. You have to be steadfast and strong in order to not be affected by these propagandas.

Your Mujahid husband and his allies are targeted by the ruthless crusaders and their agents, who mostly are members of our society. What a shame! In this war, they rely on spreading lies so that people can keep away and restrain from the methods and ways of the blessed Mujahideen. This leads to the lack of support from the youth, hence, the size of the convoy of Jihād is limited. They strive to increase the number of cowards who aren't ready to support their *deen*. Unfortunately, the infidels' propaganda has entered into some Muslim houses and twist the minds of the weak - may Allah guide them.

It is upon you to understand and be aware of the reality of this media war. You have to take into account that our enemies are recruiting whomever they can to fight against Islam. To our bitter sadness, the Muslim Ummah tends to be driven away from Jihād by misleading lectures of most of our very own scholars. Scholars who are influenced by the enemies; by just a few bucks! But *Alhamdulillah*, the Ummah has woken up, and Jihādi materials are all over the net, take your share and spread the truth.

My dearest sister in Islam, the wife of the respected Mujahid. ...

Speak up to the people around you who talk badly about Jihād. Advise them to be fair and wise and not to listen to one side and give a deaf ear to the counterpart. Let them realize that it is important, upon hearing news from the mainstream media, to confirm it from Mujahideen's media.

Wife of a Mujahid, as you may well notice, it is not enough to walk along this path only wrapped in emotions or having the desire to avenge or restoring our dignity only. Hence, it is also your duty to prepare and arm yourself with knowledge. Develop your knowledge in the fields that will help you understand the ways of the Prophets and Mujahideen. Devour the *fardh* knowledge of *Tawheed* and the essentials of *deen*.

Read the Holy Qur'an on a daily basis and make haste to know your religion better. Get accustomed to reading about the life of the Prophets, know well how they struggled, how patient they were during difficulties, and from them take lessons. Read and understand more in the life of the companions of the Prophet ﷺ. Those should be your examples and role models!

The Mujahideen - may Allāh protect them - are the raisers of the mighty flag of *Tawheed*, the followers of the Islamic *Shari'ah*, the followers of the path of our beloved Prophet ﷺ; the ones uniting the Muslim Ummah!

O mother of the upcoming Mujahideen, the obligation and responsibility to teach and enlighten your children lies on your two shoulders. They are the precious gems in your life. They are your *amānah* and responsibility. You should teach them about Islam and feed them its history, so that they can learn to love their *deen* and get ready to fight for its sake. Above all, you should immunize them from falsification and deception alleged against our true *deen*. Encourage them to seek knowledge that will benefit the Muslim Ummah.

Sister in Islam, the number of righteous people should not bother you as long as you have played your part, the truth is divine and glorious and its people are few. Allāh says, ﴿*And most of them believe not in Allāh except that they attribute partners unto Him (i.e. they are mushrikūn)*﴾ [12: 106] And Ibrāhīm - 'alayhis salām - was alone, but Allāh called him 'Ummah': A nation.

My dear ukhty, if by any chance a breeze of defeat blows upon your life or your ears are banged down by the heavy sounds of bombs and missiles, or even upon hearing

the imprisonment of some of the Mujahideen known to your husband, you should support and encourage your husband. Never abandon or desert him in this time of need.

After his first encounter with Jibrīl - 'alayhis salām - in the cave Hirā, the Prophet ﷺ was trembling with fear. At this stage, he came back to his wife Khadījah, and said, "Cover me, cover me." She covered him until he restored security. He apprised Khadījah - *radhiallāhu 'anhaa* - of the incident of the cave and added that he was horrified.

Did she lay grain or get agitated and confused? Of course not! As a wife she tried to soothe him and reassured him saying, "Allāh will never disgrace you. You unite uterine relations; you bear the burden of the weak; you help the poor and the needy, you entertain the guests and endure hardships in the path of truthfulness."

Precious sister ...

Your husband may be at the top of the most-wanted list, at a time he may also be imprisoned, deep grief and sorrow may pass by his side. At this particular time, you should be a crying shoulder for him, be supportive and be a source of strength for him.

Make him strong and when an ordeal overpasses him, say to him;

Darling, it is ok, there is no harm, ... Before you Ammār was offended, ... Before you Bilāl was patient, ...

and before you Salāhuddīn was victorious. ... And *inshaAllāh* you will win; either by victory or martyrdom.

A dark, futuristic interior with a person sitting in a chair, illuminated by blue and purple lights. The scene is dimly lit, with a strong blue and purple glow emanating from the left side, creating a sense of tension and mystery. The person is silhouetted against the light, and the overall atmosphere is one of suspense and anticipation. The background shows a complex, multi-level structure with various platforms and walkways, suggesting a high-tech or industrial environment. The lighting is dramatic, with sharp highlights and deep shadows, emphasizing the contours of the architecture and the figure of the person.

For how long will you live in tension?
Instead of just sitting, having no solution,
Simply stand up, pack your tools of destruction.
Assemble your bomb, ready for detonation.

SHATTERED

A STORY ABOUT CHANGE

— Abu Abdillāh Almorāvid —

For many decades, history took one and the same path; same lifestyle, same superpowers, same tyranny ... Many believed the world would settle this way, a few felt, "Who knows?", and even fewer believed they could make a change. So who got it right? Don't say, "Time will tell." Because it had, but did the world listen?

The September 11 attacks were not only a milestone on the road, but they were also a turning point. They carried a message from those who believe in change to the tyrants, "Let us all live in peace or else ..." Thereafter, the world became best known as 'post-September 11 world'.

The world was then divided into two: America, its allies and lackeys on one side, the Mujahideen and their Muslim Ummah on the other. Many countries gave in and joined America. Together with all these countries, America formed an alliance. An alliance which was aimed at nothing but annihilating those who are pro-change. The War on Terror began, officially.

It began in Afghānistān. The alliance opened Pandora's Box. It immersed itself into a no-win war. It invaded Afghānistān under the pretext of capturing Sheikh Usāma bin Lāden. If the Americans were clever enough, they would have had a good look into Afghānistān's recent history at least. This country defeated the Great Britain. It also repelled the Soviet Union's invasion, which unlike America had men who could endure trenches. These two great powers tasted the true nature of war, and the latter warned America from

invading Afghānistān, but the US turned a deaf ear. It turned a deaf ear to the red advice, and later to the domestic voices that called for the observance of the American morals - as we will see below.

That was more than a decade ago, now things have developed. Things have changed, a lot. America invaded a Muslim land, Afghānistān. Sometime later, it invaded Irāq, another Muslim land. You could imagine the impact these invasions had on the Muslim nation.

Whoever reads history will tell you that the Muslim Ummah is like dam water; static but full of potential energy. And if someone breaks one of its wall, he'll surely be washed away. So when America dug through one of its wall, the wall blasted water, drifting America down a river; towards a plunge waterfall, depriving it of its control over its fate.

The Immoral States of America:

Let us go back a bit in history. When we look at America after the Second World War, we find that Europe and some Eastern countries esteemed it for its role in defeating NAZI. They looked up to it as a military power with values and principles, a liberator and a human rights' protector. Later, when the cold war came to an end, many more believed America will face no match. It will police the world and the world would become a safer place. However, did this turn out to be the true state of affairs? Did this sweet dream come true?

We will not talk through the falsity of the portrayal of the nature of the morals of America, a country found on the violation of others' rights; It killed and annihilated the America's native peoples, the Indians. But we are certain that the sweet dream America propagated vanished into a terrifying nightmare: Abu Ghraib, black sites, Guantanamo and the US soldiers' crimes in Afghānistān and Irāq are too clear to need clarification. Actually, there is no possible way to express these inhumane crimes perpetrated against human rights. Here we could say America has lost the most important element of global leadership: morals and principles.

The name 'America' has become firmly connected with occupation, atrocities, violation of rights of nations and oppression to humankind. And the legend which America wove and filled with talks about values, morals, principles, freedom and human rights became crumbled.

America, a country once proud of its morals and principles, has become an 'immoral' country. Before the war on terror, it endeavored to portray itself as a country with principles, but after the September attacks, the principles' facade was thrown away. And a series of crimes negating its acclaimed morals were presented to the world.

It first invaded a country, a Muslim country, Afghānistān. It toppled its legitimate leader from Kandahār and imposed a lackey of its in Kābul. If this is morally good, then what could be bad? This American direct invasion was the first of

its kind in a Muslim country, although for decades America intervened in Muslim countries through different methods.

It then invaded another Muslim land, Irāq, and occupied it. There, the American sordid soldiers violated honors of Muslim women, as they did in Afghānistān and more. The whole world heard and witnessed the rape cases. This is the same country that shouts, "Women's rights! Women's right!"

It practiced irregular rendition, the abduction and illegal transfer of a person from one nation to another, and also 'torture by proxy' by which it transferred suspected 'terrorists' to other countries in 'black sites' in order to torture the suspects beyond the legal protection of the American law.

Obama lied in regard of the NSA program. He asserted it did not spy on its citizens. But every dog has its day, and NSA's day came when the whistleblower Edward Snowden revealed the No Secret Agency's dark secrets. The people called for the government to observe the American principles but it did not listen. It abandoned all its privacy policies.

This rogue country did not stop at spying on its citizens, it killed them too. Several of its citizens have been targeted in their extra judicial killing program. Children are not left out from this program. Abdulrahman Al-Awlaqi, a 16-year-old kid born in Colorado was targeted in Yemen while he was having supper. He was killed because his father was someone Obama did not like. In this same program, America is not respecting weaker countries' sovereignty.

Using its drones, the American regime bombards mosques, Islamic schools, women, aged people and children in Pakistan, Afghānistān, Somalia and Yemen. It hits Islamic schools for being Islamic just as it ill-treats Muslims back at home for being Muslim and still claim freedom of worship and protection of principle and morals.

This is a small fraction of America's immoral picture exhibited in the last decade alone. As we said, we will not go deep in to history and talk about America's immorality. And this is how America lost the first element to remain in the global central leadership.

Retired K-9 Dog:

The American people have no idea what war is. Playing video games does not give you the real battlefield experience in modern warfare, the post-9/11 warfare. Bullet wounds do not recover in a minute. Tanks are not invincible and false news change nothing on the ground. But the American people do not know that, they are too busy to watch over their soldiers, their sons and daughters. They are too naive not to be deceived. The bitter truth they have to gulp is that they have no military power they had before 9/11.

America is no superpower it used to be. These words may astonish many, especially those who are deluded by the power of the American arsenal. The current warfare is no 1940's; huge arsenals have no critical role. Expensive tanks, Humvees and Hummers are no match to IEDs. Mass deployments are dissolved by guerrilla warfare, and fortified areas are breached by martyrdom bombers who have great impacts on the enemy.

It is enough we know that the Irāq failure broke the will of the 'Coalition of the Willing' - the countries who supported, militarily or verbally, the 2003 invasion of Irāq - hence, America is left with no ally who would risk a gamble with his forces and sovereignty in front of the world. This became clear in the Syrian file. The allies did not support America's limited military action against Syria in response to its use of chemical weapons which are 'banned' internationally, even though Obama warned that the use of chemical weapon was a red line. After it has been let down by the allies, the weak



America justified its silence by announcing that America is no longer the world police.

Therefore, America has failed militarily as it's clear to all. It has no more adequate capability to engage in great wars to subjugate other nations, especially when we consider the economic effect of the military debacle which started immediately after the 9/11 attacks when investors lost their confidence in the American economy and when the Bush administration decided to engage in a costly military and intelligence war.

Since it does not - as Obama said - consider itself the world police, the US government prefers using unmanned drones in view of the fact that it has no capability of waging a war on the ground. Thus, these unmanned drones are more a sign of military weakness than a sign of technology advancement. The US government depends on the drones too much because it has no alternative, because it has no more the second element of global leadership: A strong military power.

Wirtschaftswunder:

Why would anyone target the World Trade Centre? In short, winning a war does not mean killing loads of people. Winning a war is about breaking the will of the enemy. And an empty stomach does that best - especially with a capitalist enemy. In other words, when the American people get stuck in economic crises and recessions, they will announce their defeat and renounce the absurd wars against other nations.

Before 9/11, this capitalist enemy had a different state of economy. Clinton's era ended with a luxury economic life to the Americans and budget surpluses. Clinton presided over the longest period of peacetime economic expansion in American history. The Congressional Budget Office reported budget surpluses of \$69 billion in 1998, \$126 billion in 1999, and \$236 billion in 2000, during the last three years of Clinton's presidency.

But the current economic state needs a literal 'Wirtschaftswunder' (economic miracle); It has a debt of over 17,000,000,000,000\$ according to government reports. If right this moment you went out and started spending



one dollar every single second, it would take you more than 31,000 years to spend one trillion dollars - do the math. If the citizens join hands to pay this debt, each citizen - including those in incubators - will have to pay over \$54000. This is only hypothetical. Citizens are either homeless, poor, jobless, bankrupt, indebted, or super-rich. The former have no means of paying such money, and the latter are too stingy to do so.

Detroit, the once automotive global center, is bankrupt. And twelve other American cities are on the brink of bankruptcy because of deteriorating bond ratings and pension obligations: Chicago, IL, Cincinnati, Oh, Compton, CA, Minneapolis, MN, Las Vegas, NV, Omaha, NE, Portland, Or, Fresno, CA, Harrisburg, PA, Trenton, NJ, Oakland, CA, Providence, RI.¹

It does not end with cities. In the mid December 2013, the Department of Defense got its share of budget cuts too. And guess who the victim is? Yeah, right, retirement buddies. Because life is not hard enough for the veterans, let us cut off more of their benefits. After all only 22 veteran commit suicide per day².

I was having a conversation with a Mujahid brother somewhere in the Arabian Peninsula. We were discussing the American military, not their buzzing drones or the Defense budget cuts. We were deep in the foot soldiers' minds. After a long discussion, he concluded, "They cry under Mujahideen's fires like babies. They leave their limbs and sanity behind in the battlefields, and others will never leave for home - and if they do, they leave in boxes. As for those returning home, they return to hell on earth," he sighed, "because of the rascality of their own government. It excludes many of the wounded vets from having access to the low Post-9/11 GI Bill benefits, unemployment insurance and any kind of benefits. That's not all, the Pentagon also gets rid of them by misconduct charges and other mean 'lawful' tricks. Veteran advocates say the American army will downsize the military by more than 80,000, and 40% of the downsizing will be accomplished through administrative separation. What a great job fighting in the American army is!" And what a great economy that cannot guarantee 'war heroes' good lives.

It is not about the economy crumbling alone. There is

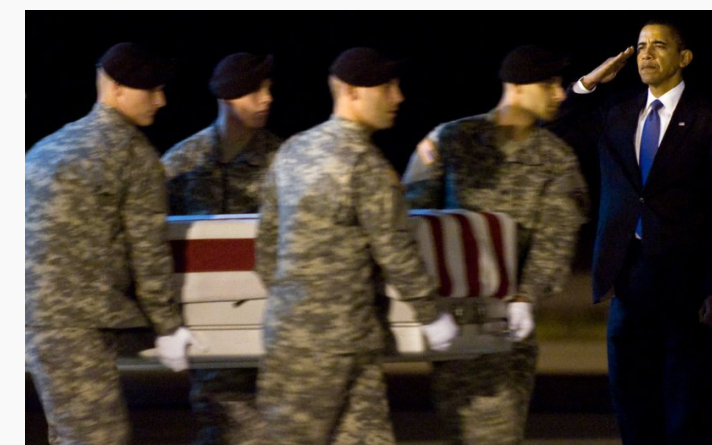

also extravagance and misuse of money by the American government and the ruling class. During 2010, an average of \$4,005,900 of U.S. taxpayer money was spent on "personal" and "office" expenses per Senator. And you need money to thank those who dragged the country in an economic war, a war of attrition: last year, 2013, 3.7 million dollars were spent to support the lavish lifestyles of former presidents such as George W. Bush and Bill Clinton.

And every American followed Senator Tom Coburn's government "Waste Book" released in December, 2013, whereas \$30 billion was wasted - including: \$500 million resort home loan guarantees, \$300 million surveillance blimp cancelled, \$4 million ruined \$100 bills, \$125 thousand dollar NASA research grant to build a 3d pizza printer that could someday create fresh pies for astronauts, and \$1 million Virginia bus stop³!

The targeting of the World Trade Centre was a success; it achieved its goal when it made the American administration pay in every way. Paying for absurd wars brings nothing but recessions and more expenditures for the homeland security. And America pays dearly: money used in the wars in Afghānistān and Irāq surpassed the WW1 and WW2 combined. It spends on anti-terror 'aids' from tax-payers' money. These aids end up in the pockets of corrupt leaders' interest, while about 50 million of the tax payers live on food stamps.

Obama said the United State of America will emerge stronger than before. He forgot the old saying "power is in the money". Strength requires money. It requires a strong economy. The English word 'economy', is traced back to the Greek word οἰκονόμος, i.e. 'one who manages a household'. Strong economy means agreeable management and strong country, and vice versa. Without the money, a country cannot run. Money is also the sticky part that holds the country together, with a weak economy, bonds become weak too, and as a result: Things will fall apart.

When an empire like America falls apart, it needs an economic miracle to rebuild its glory. Without this miracle, America has lost the third element of global leadership: economic strength.

Between two fires:

On February 1998, 'the World Islamic Front for Jihād Against Jews and Crusaders' was declared, and Sheikh Usāma bin Lāden declared war on America because it supports the occupier of Palestine, Israel, and it occupies the Arabian Peninsula by its military bases. When Americans heard this for the first time, they did not cry from terror, actually very few cared to read that part of the newspaper, and even the threatophobics - if there is that phobia - were not threatened. As we said, very few believed in change. It was impossible for the peaceful America to be unsafe. This threat from men living in caves across the Pacific was given a deaf ear.

On September 11, the World Trade Centre was destroyed, people screamed. Twelve years have passed, and they have not stopped screaming. They are terrified. You can't make a rooster stop crowing once the sun is up. When the flag of Jihād is raised, it never comes down. Sheikh Usāma - may Allāh have mercy on him - sent the 19, and raised the flag. And this flag was not carried by the Sheikh alone, his Muslim Ummah joined him to raise the flag. So when Sheikh Usāma moved on to the next life, don't think the flag fell.

There are many holders of this flag: black, brown and white, they have no common language, no specific uniform or race, and they are not separated by borders. As a journalist⁴ said, 'There is no need to send 19 to hit America anymore, a 19 year old young man could do that.'

Yes, it could be done by Lone Jihād. A 19 year old young man, even younger, could make America kneel and revise its foreign policies, and change the civil policies too. In the last dozen years we have seen great Lone Mujahideen. Fort Hood, Texas, November 5, 2009, Nidāl Hassan shot 19 officers dead. There are more fingers on the trigger out there. Charles Bishop, 15, that Mujahid who flew with a plane and crushed it into the Bank of America Tower. He left a note stating that he voiced support for Sheikh Usāma bin Lāden⁵. There is Abdul Hakim Mujahid Muhammad, Ja'far the pilot, Hassan Akbar, Feisal Shahzād, Shariff Mobley, Colleen La Rose, Tsarnaev Brothers and many many more.

These types of attacks, Lone Jihād, have devastating effects on the enemy. There is no need to present them here. All previous issues concentrate on Lone Jihād (For economy losses refer to America's Bitter Harvest⁶). It is almost impossible to talk of Lone Jihād in this age and not mention Sheikh Anwar Al-Awlaki. This Imām, through his inspiration, made the Washington regime quack and quake in its shoes. And his martyrdom gave life to his words, may Allāh accept him among the martyrs.

Even without Lone Jihād, life in America has become unbearable due to the recurring random shooting incidents. The good days are over, them days when a mom hugged her daughter, "Sweetie, walk back from school safe." Now she

says, "Sweetie, stay safe in school. Any sound, run and run and run. Don't forget Sandy Hook." This same lady fears for her husband's safety at work. Who could blame this lady for being worried? Who could blame any American for being worried, or being sensible by taking precautions? Even security forces and officers are worried. And they should be. The Navy Yard Shooting is still fresh in their minds.

In the late 80's, Patrick H. Sherrill who killed 14 of his colleagues was a unique case. He then earned the title 'Crazy Pat'. Now there are loads of Pats in America, but none is titled 'Crazy'. Because everyone knows insanity alone cannot recruit all this number of triggermen.

Did you know that since the New Town shooting in the middle of December 2012, roughly 11,610 people were killed by gun homicides?⁷ Holmes thought he was Joker - he had to kill Batman ... others kill innocent children. But craziness alone does not cause random shootings. There are many asylums, and the US is not the only country with crazy people. The problem is not neuro-related, it is policy-related, both foreign and civil: there is no traveling freely, mass surveillance, indebted citizens, even the health system is a failure. How do you expect a people used to luxury life sustain such a life? Of course there will be random shootings. It is a case of chickens coming home to roost - and chickens coming home to roost never did make me sad; they've always made me glad.

Therefore, America's symbolic portrayal has fall in the world's mind. It has lost the war militarily and it is entangled in economic crises. Things did not stop there. Rather, it lost its homeland security. It lives between two fires: Lone Jihād and homicides that increase day by day.

If you do not possess a good reputation, a terrifying military power, you have no enough money, and cannot protect yourself from security threats, then you are shattered. ... This is a story about change. ... But, will the world listen?

1- Moody's investors service Stephen Moore & Doug Ross.

2- Veterans Affairs Report

3- Fiscal Times

4- Abdulilah Haidar Shaye', City Wolves, Source: www.facebook.com/abdulela & www.twitter.com/abdulela

5- CNN, 2002 - 01 -07: "Police: Tampa pilot voiced support for Bin Laden."

6- Inspire Issue 11 - America's Bitter Harvest by Muhannad Jannah Seeker.

7- Slate.com



Inspire's Lens: Prior to the attack on the Yemeni Ministry of Defense
(Right: Abul 'Izz Al-Muteiry - may Allāh accept his martyrdom)

tourists end of safari en

END OF SAFARI

HSM Press Office:

Kenyans will not appreciate the gravity of the situation without seeing, feeling and experiencing death in all its ghoulish detail.

HSM Press Office:

The message we are sending to the Kenyan govt & Public is and has always been just one: remove all your forces from our country.

"There is no way that you, the Kenyan public, could possibly endure a prolonged war in Somalia and you cannot also withstand a war of attrition inside your own country. So make your choice today and withdraw all your forces from the Islamic Wilāyat, otherwise be prepared for an abundance of blood that will be spilt in your country, economic downfall and displacement."

**Shaykh Mukhtār Abu Zubeyr,
Amir of Harakat Al-Shabāb Al-Mujahideen**

Why Target Nairobi's Westgate Mall?

"It is a place where tourists from across the world come to shop, where diplomats gather, ... where Kenya's decision-makers go to relax and enjoy themselves. ... a place where there are Jewish and American shops."

**Sheikh Abu Muscab
Harakat Shabāb Military Spokesman**

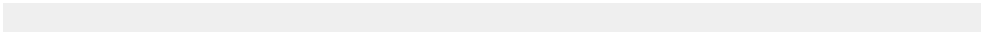

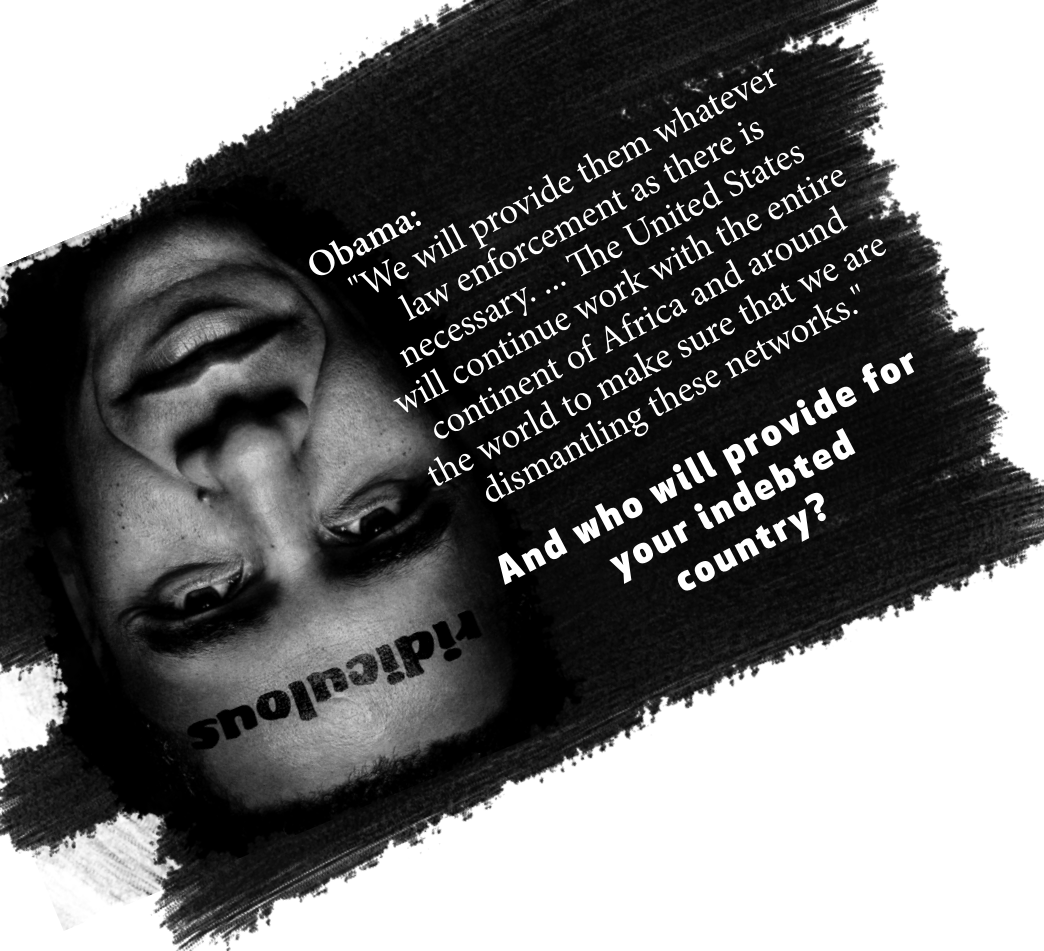

Obama:
 "We will provide them whatever law enforcement as there is necessary. ... The United States will continue work with the entire continent of Africa and around the world to make sure that we are dismantling these networks."

And who will provide for your indebted country?

ridiculous!

9/11

ON THIS DATE:
 Kenyans witnessed a retributive justice for crimes committed by their military in Somalia, albeit largely miniscule in nature as several Mujahideen from Harakat Shabab stormed into an American-Jewish owned mall in Nairobi. More than 137 people were killed including Americans, Britons, French, Canadians and Australians while hundreds were injured. American, Israeli and Kenyan forces and intelligence launched several attempts to lift the siege but all in vain. After 80hrs, they gained full control of the mall BUT NO ONE was in the complex. Later a sewage tunnel was discovered in the mall.

'PEACE' AND AMISOM

To understand the present u must study the past,
 To prevent more reaction u better make change fast.
 2007 this bloody chapter began,
 During the invasion of Irāq and Afghānistān.
 Ethiopia had invaded the land of Somāl,
 To prevent the establishment of Law of Allāh.
 And to pillage and plunder, rape and kill,
 So the Muslims rose up with might and will.
 It was at this time AMISOM was concocted,
 Legitimacy and image was what was wanted.
 The awake and intelligent not fooled in the least,
 As time went on the deaf and dumb could see.
 That all the *kuffār* came with the same goal,
 And they understood perfectly AMISOM's role.
 Uganda in the lead and Burundi coming second;
 Itchy trigger fingers and loads of weapons.

They taught the people what the meaning of peace,
 Is as the people learn to identify the body pieces.
 They taught the business people how to close up shops,
 As they bomb Bakaro and Suuq Ba'ād.
 They showed how to care for the sick and weak,
 As they bomb the hospitals like Keyseney.
 They showed how to manage transport and streets,
 By firing on packed buses randomly.
 They taught the people to turn to their Lord and pray,
 as *Janāza* is prayed numerous times a day.
 They taught how to own up to one's own deeds,
 as they deny their obvious crimes most arrogantly.
 They taught how to slaughter and prepare the meat,
 as the slaughterhouse is bombed most regularly.
 They taught how to keep up and repair homes,
 By turning whole areas into ghost zones.
 They taught the importance of a good night's sleep,
 As the mortars keep raining down hourly.
 They taught the people that justice is blind,
 As the babies are buried time after time.
 They taught the people what the meaning of peace,
 Is as the people learn to identify the body pieces.

-Abu Anwar Al-Muhājir
 Al-Shabaab Mujahid Bro

Peacekeepers

- UGANDA
- KENYA
- BURUNDI
- SIERRA LEON
- ETHIOPIA
- DJIBOUTI



Worries Begin

Westgate was not a fight, it was a message. The real fight is on the way.

-Sheikh Ali Dhere,
 HSM Spokesman

~~JAHILIA~~



Open Source Jihad

In this section:

Car Bombs Inside America
Car Bombs - Field Data

Open Source Jihad

o•pen | 'ōpən| source |sôrs| ji•had |ji'häd|
A resource manual for those who loathe the tyrants; includes bomb making techniques, security measures, guerrilla tactics, weapons training and all other jihād related activities.

- informal A disaster for the repressive imperialistic nations: *The open source jihād is America's worst nightmare.*
- It allows Muslims to train at home instead of risking a dangerous travel abroad: *Look no further, the open source jihād is now at hands reach.*

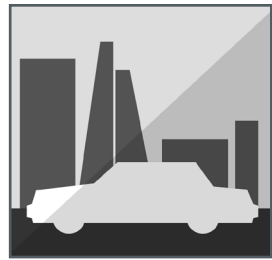

CAR BOMBS INSIDE AMERICA

w/ AQ Chef

REQUIRED COMPONENTS

- Cooking Gas Cylinders (6 or more)
- Oxygen Gas Cylinder (full)
- Barometer (suited to the Cooking Gas Cylinder)
- Connecting nut and pipe
- 6 Decoration lamps
- Match
- Epoxy
- Tissue
- Battery (12v or more)
- Wire



Epoxy

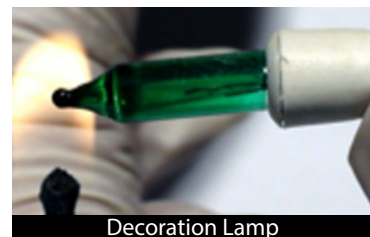

Decoration Lamp



Barometer



Connecting Nut

Inspire Magazine's goal is to empower Muslim youth. And what is empowerment without being strong, powerful and intelligent? In this section, we give you strength, power and intelligence. Believe me, using car bombs gives you all that.

It is absolutely simple. And we will make it simpler for you, *biidhnillāh*, so that every Muslim, who loves Allāh and His Messenger, and wants to accelerate Islam's victory, becomes prepared to make, even if this is the first military material his eyes has set on.

This recipe gives you the ability to make a car bomb even in countries with tight security and surveillance. The reason is: primary materials easily available and they do not raise suspicion. These materials are not explosives in nature. But after you have assembled and prepared them, they become a bomb ready for destruction, *biidhnillāh*.

This type of car bomb is not usually used to destroy buildings, but is very effective in killing individuals.

The merit of this method is that you can prepare a car bomb in a few hours during the availability of the primary materials. So there is less worry about your personal security.

My Muslim brother, before you start reading the instructions, remember that this type of operation if prepared well and an appropriate target is chosen and Allah decrees success for you, history will never forget it. It will be recorded as a crushing defeat on the enemies of Islam.

THE GENERAL IDEA:

We are going to mix two gases; one an oxidizer, another a fuel, in one sealed container that will change the normal combustion of the two materials into an explosive combustion. The explosion will start as soon as a flame emitted from a torch comes in contact with the gas that will burn rapidly under very high pressure.



Cooking Gas Cylinder



Oxygen Gas Cylinder

OPERATIONAL IDEA:

- Pure 'Oxygen' was used as the oxidizing gas, cooking gas 'Propane' as the fuel, and Cooking Gas Cylinder as the sealed container.
- An amount of gas was discharged from the Cooking Gas Cylinder.
- The highly pressurized Oxygen Cylinder was connected to the Cooking Gas Cylinder.
- When the safety valves of both the cylinders were opened, Oxygen Gas moved into the Cooking Gas Cylinder directly. This was caused by pressure difference.
- The pressure inside the Oxygen Cylinder was very high compared to that inside the Cooking Gas Cylinder. We know that gas moves from a high pressure region to a lower pressure region.

PRESSURE DIFFERENCE:

- While the tap is closed, the pressure in the yellow balloon is zero, while the pressure in the red balloon is one.

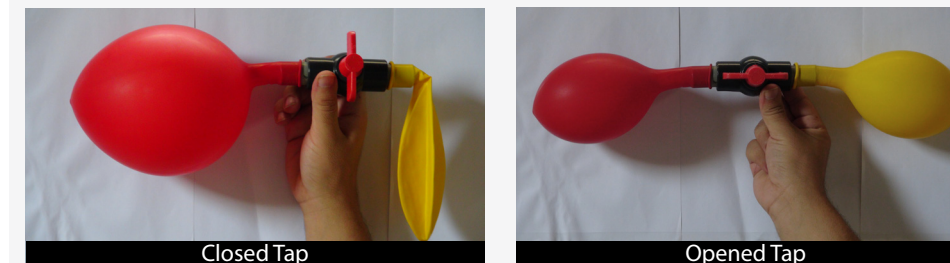

Closed Tap

Opened Tap

- But when we open the tap, gas moves from the high pressure region (red balloon) to the low pressure region (yellow balloon) in such the pressures in the two balloons become equal.

BAROMETERS:

Pressure measuring instruments are called 'barometers'.

There are different types of barometers, some measure up to 11 bars, others up to 280 bars, and others in between. Barometers used to measure tire pressure usually measure up to 11, 12 or 16 bars.

Barometers used for gas cylinders differ as per the type of the cylinder. For example, large Oxygen cylinders use barometers of 240 bars or 280 bars. Medium cooking gas cylinders use barometers of 34 or 36 bars. There are also many other types of barometers.

Barometers use different units, some use bars, others 'atm', pound per square inch (psi), Pascals (Pa) or millimeter of mercury (mmHg).

Here are some barometers:



Regulator

1. This barometer is sometimes called a 'regulator'. We will use it in these instructions. The meter on the right measures the pressure in the oxygen cylinder - its maximum measurement is 28,000 kiloPascals (kPa), equivalent to 280 bars. While the meter on the left measures the cooking gas cylinder - its maximum measurement is 1400 kPa, equivalent to 14 bars.

PRESSURE UNITS:

- The standard atmosphere that we live in is a unit of pressure.
- The standard atmosphere is almost equal to one bar (1 bar ≈ 1 atm).
- In this procedure we are going to use 'bar' as the standard pressure unit for the gas cylinders.
- When you come across any other unit in your barometer e.g. Pascals, kiloPascals or psi, convert it into bar.
- Conversion is very simple, all you have to do is use a converter in your computer OS calculator.
- A Cooking Gas Cylinder can sustain up to 12 bars.
- An Oxygen Cylinder can sustain up to 135 bars.
- 'kg/cm²' is the same as atm (atmosphere).

HINT

- You can use oxygen from medical or welding cylinders.
- You can also use other fuels instead of propane, e.g. hydrogen, methane or acetylene.
- These fuels give better results, if security measures allow you to buy.



Tire Barometer



Regulator 2



Tire Barometer 2

2. This tire barometer can measure up to 11 bars. We will use it in our procedure.
3. The meter on the right measures a maximum of 25 atmospheres - almost equivalent to 25 bars, while the meter on the left measures a maximum of 2.5 atmospheres - almost equivalent to 2.5 bars.
4. This tire barometer can measure a maximum of 16 bars.

CAR BOMB PREPARATION:

1 - Mixing the Gases:

- Discharge gas from the Cooking Gas Cylinder until only 3 bars are left in it.
- Note: to be sure of the required amount, you have to measure the pressure after every few moment of releasing the gas. Use a barometer suitable for the cooking gas cylinder.
- Note: If you do not have the suitable barometer, there is a simple way to measure the pressure by a tire barometer (fig 1.1):
- Take a normal cooking gas regulator and cut its connecting nut off. Use a hacksaw to cut at the yellow mark. (fig 1.2)
- Take a tire's inner tube and cut the valve stem off, in such its lower part fits the nut. (fig 1.3)
- Fit the valve stem into the nut precisely.
- Apply epoxy from the outside to provide a strong adhesion between the valve stem and the nut and prevent the gas from leaking. Also apply a little of epoxy inside - Do not block the hole. Now the nut is ready to use with the tire barometer and the Cooking Gas Cylinder. (fig 1.4)



1.1. Tire Barometer



1.2. Cooking Gas Regulator



1.3. Nut and Valve



1.4. Final Result

2- Connect the Oxygen Cylinder to the Cooking Gas Cylinder.



Connecting Nut

Note: to be able to insert Oxygen Gas into the Cooking Gas Cylinder, you should have the connecting nut illustrated in the photo.

If the connector is unavailable, or buying it may draw attention to you, you can use a normal cooking gas regulator with a bit of modification. You will have to drill a hole from the inside to let Oxygen Gas pass into the cylinder.



2.1. Interior Spot



2.2. Exterior Spot

3 - Insert 9 bars of Oxygen Gas into the Cooking Gas Cylinder.

This will make the total pressure inside the Cooking Gas Cylinder 12 bars. (fig 2.3)

Avoid heat and fire sources while inserting or discharging gas!

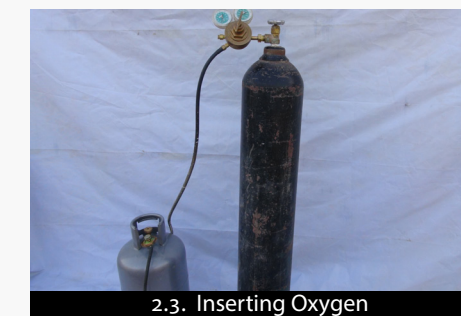

2.3. Inserting Oxygen

4 - Preparing the ignition lamp:

- The ignition lamp is the tool that emits a flame into the mixed gas inside the Cooking Gas Cylinder, to detonate the bomb.
- Break the top of the decoration lamp by heating it. Make sure the filament does not break.
- Fill the lamp with match (from matchstick heads). (fig 3.1)
- Seal it with a tissue. (fig 3.2)

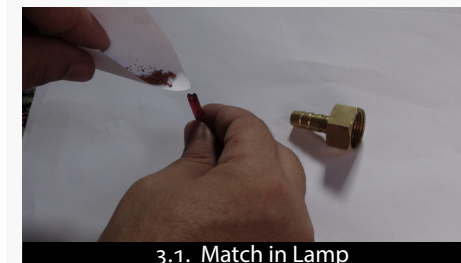

3.1. Match in Lamp



3.2. Sealing

SECURITY MEASURES:

- If you are planning to hide your identity and cover your trail during the operation, begin from the time you set your feet to purchase the ingredients.
- Wipe your fingerprints.
- Use a car that will not reveal your identity.
- Avoid cctv cameras.

FIG : 2.1 & 2.2

The spot to be drilled.

HINT

You can collect the gas in one Cooking Gas Cylinder instead of six cylinders, as long as the pressure is not lower than 12 bars. The higher the gas pressure the stronger the explosion.

IMPORTANT



It is better to start preparing the car bomb few hours before the operation, because the security forces (if they come into your work place/house) cannot accuse you of preparing a bomb, especially if you distribute the ingredients in your house well.

FIG : 4.1

A Cooking Gas Cylinder Bomb. You have completed the preparation of one cylinder, now prepare the other cylinders in the same way (to make a total of not less than six).

MAXIMUM CARNAGE



- It is better to use shrapnel (nuts, ball bearings, nails or any other) on the outer surface of the cylinders.
- The best way to arrange the shrapnel is in circles.
- In this car bomb you can use up to 100,000 pieces of shrapnel.
- A hand grenade usually contains 360 shrapnel only.

5 - Inserting the ignition lamp

- Insert the lamp into the connector, while the wires are out.
- Apply epoxy to seal the connector or the modified regulator.

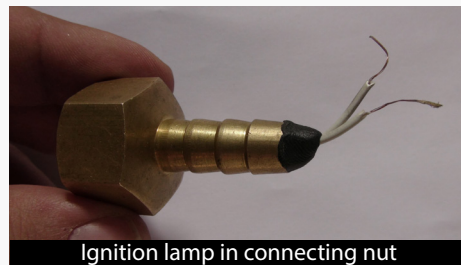

Ignition lamp in connecting nut



Ignition lamp in modified regulator

- Fasten the connector to mixed gas cylinder.



4.1. Cooking Gas Cylinder Bomb

6 - Preparing the Car-Bomb:

- Prepare no less than six 25-litre cylinders.
- Place them closely to each other. Leave as little space between them as possible.
- Connect the ignition lamps.



Car Bomb without Electrical Circuit

7- Preparing the electric circuit: (connecting the cooking gas cylinders)

Every ignition lamp has two wires. Connect the wires on the right to the positive pole (+) of the battery (12v or more), and the wires on the left to the negative pole (-).

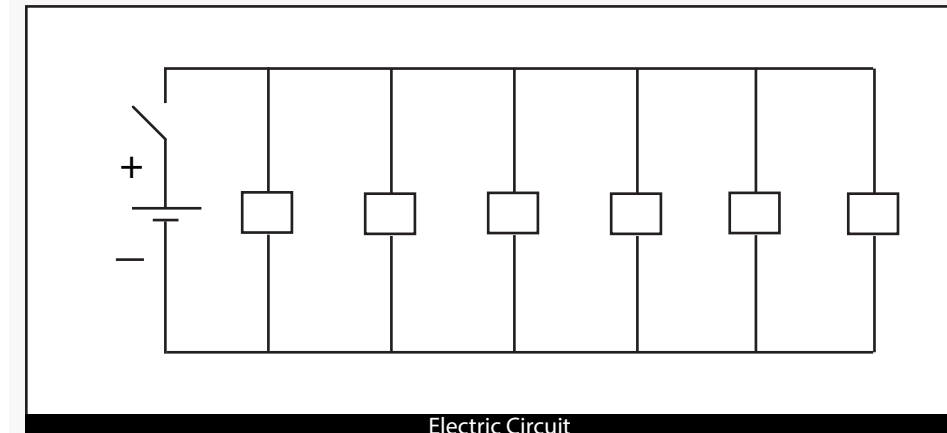

Electric Circuit

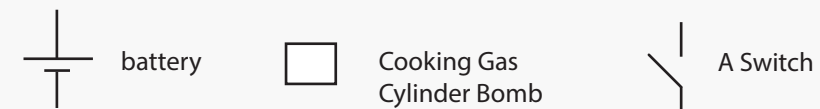

- When these two wires are connected to the battery the car will explode.
- THAT IS WHY YOU SHOULD PUT A SWITCH ON THE POSITIVE SIDE SO THAT YOU CAN CONTROL WHEN TO DETONATE THE CAR BOMB, AND PROTECT THE CIRCUIT FROM UNINTENDED DETONATION.
- Note: It is recommended to test the electric circuit using another decoration lamp of the same type used for ignition.
- If you are a martyrdom bomber and you want to detonate the car bomb directly, use a manual switch that is operated by hand directly.
- If you want to make it a time bomb, use a time switch (you can refer to Inspire Magazine issue 1 and 9 for details).
- If you want a remote detonation, use a toy-car remote, alarm remote, garage remote or any other. You can test the remote with a lamp (or refer to issue 8 for details).

That's all there is to it



REMEMBER

If you intend to hide your identity buy a car without any formal paperwork being exchanged.

IMPORTANT



If it possible, carry out an experiment even if in a smaller scale in a safe place, because an experiment will give you lot of experience before the main operation.

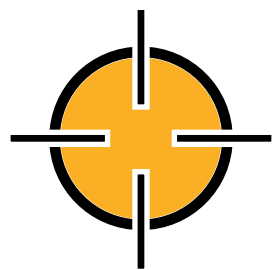

CAR-BOMB: FIELD DATA

w/ AQ Chef

Choosing the place and time is a crucial factor to success in any operation. Choose targets in your own country. You know the enemy better, you are within. We will point out some general and specific targets as an example.

IMPORTANT



This type of car bomb is used to kill individuals and NOT to destroy buildings.

Therefore, look for a dense crowd.

THINK OUTSIDE THE BOX

Be creative in your Jihad. This is 'Open Source Jihad'. Surprise the enemy, don't follow a particular protocol. Believe me, there is no SOP for the kind of car you are riding.

GENERAL TARGETS:

America is our first target, followed by United Kingdom, France and other crusader countries.

As for the field target for the car-bomb, you have places flooded with individuals, e.g. sports events in which tens of thousands attend, election campaigns, festivals and other gathering. The important thing is that you target people and not buildings.

SPECIFIC STATES AND CITIES IN THE UNITED STATES:

- Washington DC and New York:

Washington is the capital, and New York is the former capital. Both have symbolic importance to the American people and government. Moreover, White House is in Washington, and DC has about 347,000 federal government employees and many important figures in the government live there. As for New York, it is known for its status as a financial, cultural, transportation, and manufacturing center, it is the leading center of banking, finance and communication in the United States.

- Northern Virginia:

It has a big military presence, almost all the military bases are based in this state, apart from the Air Force which is based in Chicago. There are federal agencies in Northern Virginia, including the headquarters of the Department of Defense and CIA; and military facilities in Hampton Roads, the site of the region's main seaport. Virginia in general attracts a load of tourists.

- Chicago:

It is in the mid of the US, hence it is a major transportation hub. It is an important component in global distribution, as it is the third largest inter-modal port in the world. It is also an important worldwide center of commerce. The city has the second largest financial center in the United States. Among its most important financial structures:

1. Sears Tower, a 108-story skyscraper, it held the title tallest building in the world for about 25 years.
2. The Chicago Board of Trade Building.

- Los Angeles:

The most populous city in the state of California, and the second most populous in the United States. It is also the largest manufacturing center in the western United States. It is also the home base of Hollywood.

SPECIFIC TARGETS:

Areas and Restaurants with high profile personalities - Usually these people visit the restaurants during the weekend:

- Arlington
- Alexandria
- Restaurants and Bars in the M street, Washington.
- Tennis stadiums; they are visited by thousands of people, and high profile people, especially the US Open.

SPECIFIC TIMES:

- During the election seasons, both presidential and Congress.
- During Christmas and New Year's Eve, 25th and 31st December.

SPECIFIC TARGETS IN THE UNITED KINGDOM:

There are many times and places to be targeted.

- You have the soccer (football) stadiums especially during Premier League and FA Cup matches. They have worldwide life media coverage. The best time is after the final whistle, when huge crowds leave the stadium and celebrate around the entrances.
- In the beginning of summer, we have Cheltenham, and the end of summer we have Epsom, whereby horse races are attended by thousands from around the kingdom including the Queen.
- There are also Tennis tournaments.
- It is worth to mention a more specific target, Savoy Hotel located on the Strand in central London. At about 10 pm GMT, businessmen and high profile targets leave the hotel. This is a perfect place and time to detonate your car bomb.

SPECIFIC TARGETS IN FRANCE:

- With over 82 million foreign tourists per annum, France is ranked as the first tourist destination in the world, beaches and seaside resorts, ski resorts, and rural regions that many enjoy for their beauty and tranquility (green tourism).
- The Transport express régional (TER)'s stations. Rush hours will always do.
- The Dordogne valley, during summers. Hit two birds with one stone; both the English and the French.
- The Coupe de la Ligue; only open to professional clubs. Expect huge crowds of supporters outside the entrances.
- The Bastille Day Military Parade: the morning of 14th July each year in Paris.
- During special exhibition in the Musée du Louvre: the most visited art museum in the world and a historic monument.
- The French Riviera.

GIVE 'EM WAR

US, UK and French police force are not used to a frontline-type war. They cannot withstand a bang of a grenade, let alone a full car bomb blast.

REMEMBER



Disguise yourself during the operation, appear fat (add some clothes on you), change your complexion, be a 'clone', use any mask (believe me embarrassment is the last thing you will think about), wear a mask suitable for the festival, white beards on 25th Dec. All in all, be creative brother. The most important part to hide is your eyes and around.

? DID YOU KNOW?

France's enmity towards Islam is no secret. It does not even use pretexts to invade Muslims. What happens in Central African Republic is enough evidence. It invaded the country to help the Christian militia fight the regime Army for its relation to Islam

LOGIC

When targeting high profile places, go for the entrance; you cannot get a car into most of these targets. But what goes in, comes out; there should be an entrance.



Al-Malahem Media



the right man in the right place devastates the enemy

CHOOSE WISELY